



**Minnesota  
Pollution  
Control  
Agency**

---

# **Wastewater Treatment Technology**

**1997 Edition**

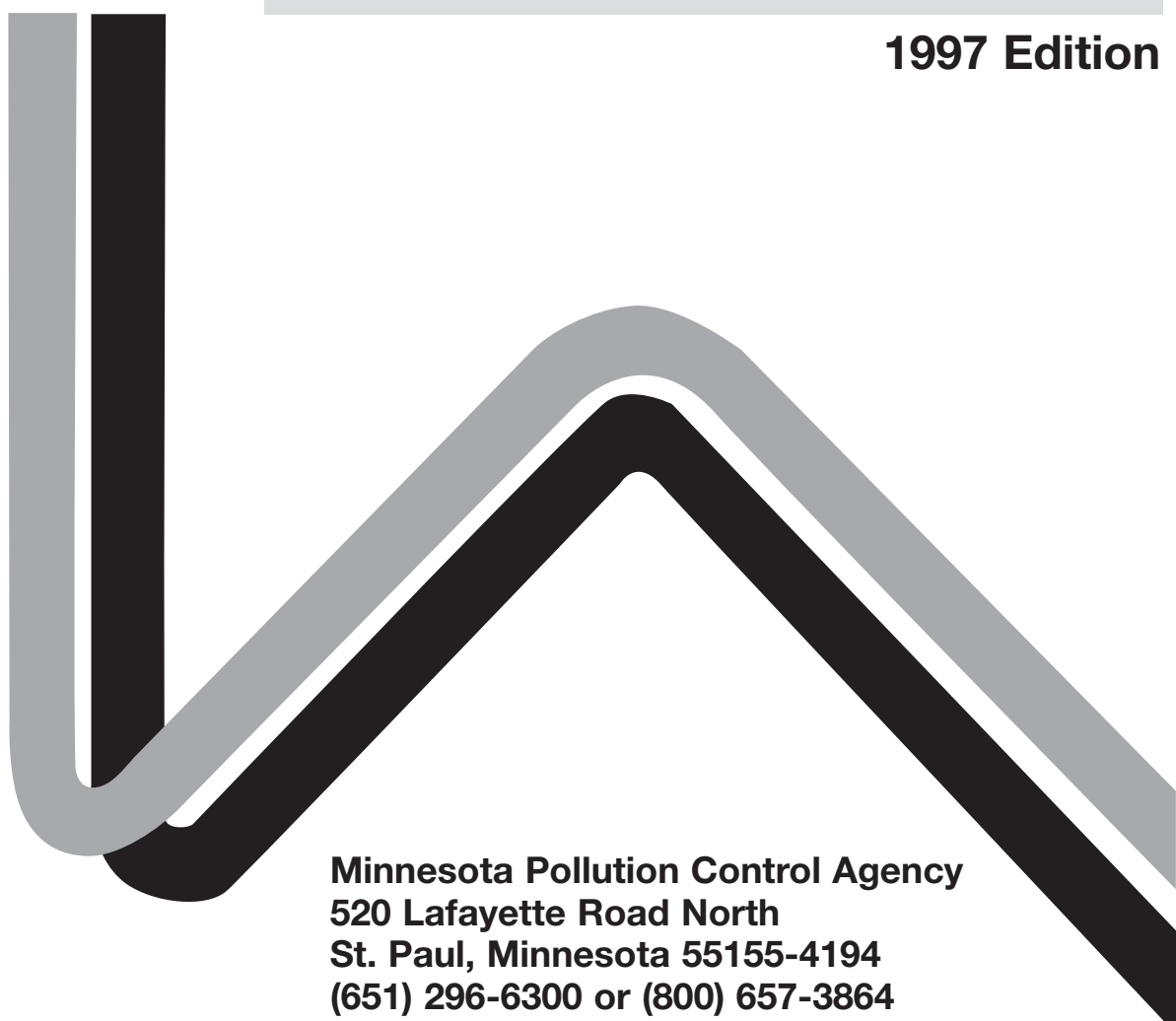
A large, stylized graphic element consisting of two thick, parallel lines. The top line is grey and the bottom line is black. They start as a vertical line on the left, curve to the right, then curve back to the left, and finally curve to the right again, ending in a diagonal line pointing down and to the right.

**Minnesota Pollution Control Agency  
520 Lafayette Road North  
St. Paul, Minnesota 55155-4194  
(651) 296-6300 or (800) 657-3864**

# WASTEWATER TREATMENT TECHNOLOGY

by

Emily Armistead  
Patricia Burford  
Russ Degerstedt  
Art Dunn  
Gene Erickson  
Del Haag  
Mike Hansel  
Cyndy Hanson  
Mike Herman  
Roger Karn  
Deb Lindlief  
Becky Lofgren  
Dwayne Nelson  
Bill Sexauer

First Printing - June 1982  
Second Edition - June 1986  
Third Edition - November 1997

Water Quality Division  
Minnesota Pollution Control Agency  
520 Lafayette Road  
St. Paul, Minnesota 55155-4194

## PREFACE

Wastewater Treatment Technology is based largely on the series of handouts we developed for use at our training courses. We have also incorporated information from several other sources around the country and from the best source of all -- you the operator. In our experience doing training courses, you have taught us a lot. We hope this manual will be of as much help to you as you have been to us.

## ACKNOWLEDGMENT

Special thanks to Ken Kerri at California State University, Sacramento, for the use of pictures and diagrams which appear in his self-study training course, Operation of Wastewater Treatment Plants.

Also, thank you to the operators everywhere whose valuable contributions made this manual possible, and an extra special thank you to Emily Armistead and Mary Osborn for all of their time spent in organizing and typing this manual.

## DISCLAIMER

Any reference to commercial products in this manual are for illustrative purposes only and do not constitute endorsement by the Minnesota Pollution Control Agency.

## TABLE OF CONTENTS

<u>CHAPTER</u>		<u>PAGE</u>
1	Collection Systems	1-22
2	Introduction to Wastewater	23-44
3	Preliminary Treatment and Clarification	45-64
4	Trickling Filters	65-90
5	Rotating Biological Contactors	91-104
6	Activated Sludge	105-130
7	Stabilization Ponds	131-148
8	Soil Treatment Systems	149-166
9	Disinfection	167-178
10	Solids Handling	179-197
11	Sampling	198-209
12	Glossary	210-242

## INTRODUCTION

This manual was developed to provide beginning wastewater treatment operators with an overview of wastewater treatment and a basic understanding of the various treatment processes. The manual is also useful to veteran operators for learning more about those treatment processes which are different from their facilities.

While the manual discusses the operation and maintenance of most types of wastewater treatment units, it is not meant to provide all the information needed to operate a facility. Entire manuals are devoted to the discussion of individual units or processes. Many of these manuals are listed at the end of each chapter for further reading.

The manual is organized, as much as possible, to follow the normal path of wastewater through a treatment facility. It starts with the collection system, then goes through preliminary and primary treatment. Various secondary units are discussed, followed by disinfection and solids handling.

Someone once said there are three reasons why a job doesn't get done. Either the person who is supposed to do the job: 1) doesn't know how; 2) doesn't have the right tools; or 3) doesn't want to do it. This manual is designed primarily to tackle the first reason -- lack of knowledge. While no one manual can totally accomplish this task, this manual starts that process.

Manuals, of course, cannot supply tools, nor can they provide the desire to do a job, or to do it well. This comes only from operators who start to think of themselves as professionals.

Many people think that operating a wastewater treatment facility means turning a few nuts and bolts, changing oil and mowing the grass. This is simply not true. Operators must be chemists, plumbers, biologists, electricians and mathematicians, as well as public and labor relations experts. In short, an operator is really the manager of an expensive facility whose products are clean water and treated wastes.

Operators cannot manage their facilities along. For the plant to run properly, there must be teamwork -- a partnership between the owner and operator.

The owners of a wastewater treatment facility are ultimately responsible for its operation. Their names are on the permit, and the operator reports to them. The owners might be the mayor, city manager, city council, the board of a sanitary district or a private corporation.

Operators are the people who actually operate and maintain the wastewater treatment facility, including buildings, grounds and equipment. Operators are the professionals who make the day-to-day decisions on how the facility should be operated.

In short, the owners are responsible for providing the necessary tools and materials needed to properly operate and maintain the facility. This includes laboratory and safety equipment. The owners are also responsible for providing or obtaining funds for plant expansion or major modifications. The owners should provide opportunity, time and incentives for the operators to maintain and improve their level of expertise. This can include membership in professional organizations, attendance at training courses, or subscription to journals or correspondence courses which relate to wastewater treatment. Finally, the owners should treat the operators as professionals by consulting them before making any changes in operation or policy, and by establishing a salary level which encourages retention of skilled and experienced personnel.



The operators are really the key to the performance of the facility. They protect the environment and the public health by providing continuous treatment and disposal of wastewater. They protect the owners by performing preventive maintenance, by keeping accurate records and by complying with state and federal regulations. Operators should use good health and safety practices at all times to protect themselves and others at the facility.

Operators are also responsible for keeping people informed. Owners of the facility should be notified in advance of the need for tools, parts, supplies and possible future facility expansion, in order to make allotments in the budget for these costs. The public should be informed about the plant's operation and any emergencies which develop. Addressing complaints, answering inquiries from the news media and conducting plant tours are some additional responsibilities the operators have to the public. Operators must keep the state regulatory agency informed about plant operations and any emergencies by filling out monthly report forms and returning them on time. Finally, they should keep up-to-date on the latest methods and techniques in wastewater treatment through training courses, journals and professional organizations.

Communication among the owners, operators, community and state regulatory agency is very important in order for the treatment facility to be operated properly and efficiently.

A sample *Annual Report* and *Annual Budget* follow to help illustrate some ways in which this communication can be established.

## ANNUAL REPORT

This year the \$1.5 million Plantville Wastewater Treatment Facility treated the wastes of Plantville's 800 residents and local creamery; a total of 100,000 gpd or 36.5 million gallons this year. The plant complied with its permit requirements except for two occasions, during the month of January when the final clarifier froze, and on June 7 when 12 inches of rain fell in eight hours. Continuous service was provided to all but 20 homes on June 7 when the sewers backed up.

In addition to the regular operations and maintenance of the plant, two major projects were completed this year: installation of 2,000 feet of sewer (Byer Avenue extension) and construction of covers for the final clarifiers to prevent freezing. Electrical costs were reduced 25 percent by using the new dissolved oxygen meter purchased last year. This savings more than paid for the cost of the meter.

The budget for the coming year includes funds for replacing the pump in the main lift station and repairing 1,000 feet of sewer on South Main Street.

## ANNUAL BUDGET

The following is a list of some of the items which should be in the annual budget.

Salary and Benefits	Equipment Replacement
Electricity	Laboratory Equipment and Supplies
Chlorine	Insurance
Natural Gas	Training
Gasoline	Travel (for training)
Equipment Repair (parts)	Miscellaneous (includes material for sewer repair)

In summary, the purpose of this manual is to provide, at least in part, the knowledge of how a wastewater treatment facility operates. The owner provides the tools; the operator must provide efficient plant operations. If the operator has, or can acquire, that professional attitude, tools and knowledge will be easier to obtain.

# COLLECTION SYSTEM

## TABLE OF CONTENTS

	<u>PAGES</u>
<u>INTRODUCTION</u>	2
<u>COLLECTION SYSTEMS AND COMPONENTS</u>	2
Types of Collection Systems	
Basic Parts	
Material Used	
Manholes	
Lift Stations	
<u>OPERATION AND MAINTENANCE</u>	6
Pipeline Maintenance and Inspection	
Major Equipment	
Inspection	
Lift Station Operation & Maintenance	
Bar Screens and Baskets	
Dehumidifiers	
Ventilation	
Dry Well Dewatering	
Emergency Operation	
<u>VELOCITY, FLOW MEASUREMENT AND RECORDING</u>	14
Velocity	
Flow Measurement	
Flow Recording	
<u>SAFETY</u>	18
<u>REFERENCES</u>	22

## INTRODUCTION

The wastewater collection system is probably the oldest part of a wastewater facility. There is evidence that collection systems were used in India around 3750 B.C. The oldest sewer still in existence is an arched sewer built in Rome around the first century. It was used for carrying waste from the Roman Forum to the Tiber River.

These old collection systems were all gravity flow sewers. Today, most collection systems are still designed as gravity flow, but in some cases, due to the topography of an area, lift or pumping stations must be provided to help convey wastewater to a treatment plant.

## COLLECTION SYSTEMS AND COMPONENTS

A wastewater facility has many parts. These parts include pipes, conduits, structures, equipment and other processes used to collect, transport, treat and dispose of domestic and industrial wastes. The processes of a wastewater facility which we will discuss include both the collection and transportation of wastes (a wastewater collection system).

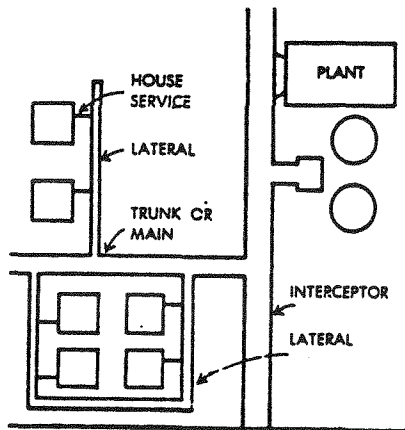

Typical layout of a City Sewer System

### Types of Collection Systems

There are three basic types of wastewater collection systems in use today: storm, combined and sanitary sewers.

#### **Storm Sewers**

Storm sewers are the oldest of the three collection systems. Runoff water from streets, parking lots and developed areas enters into chambers or openings built into

the curb line of a street or parking lot. It is then carried away to a suitable area (these are not used with sanitary sewers).

### **Combined Sewers**

The combined collection system is nearly as old as the storm sewer. During dry weather the combined system carries wastewater, but during rainfalls it is also used to carry off rainwater. Many older cities still have these systems since most of them already had storm sewers. It was easier and less costly to hook up homes and industries to storm sewers than to build a completely separate sanitary collection system.

### **Sanitary Sewers**



Separate sanitary collection systems were introduced to this country around the turn of the century. The function of these systems is to collect and transport domestic and industrial wastes to wastewater treatment plants where they can be treated and disposed of properly.

### Basic Parts

All three types of collection systems collect and convey wastewater by using the following parts.

### **Building Sewers**

Building sewers are used to collect wastewater from a building's plumbing and to convey it to a lateral sewer in the street.

### **Lateral or Branch Sewers**

Lateral sewers collect domestic and industrial discharges from building sewers or catch basins and transport them to a main sewer.

### **Main Sewers**

Main sewers collect wastewater from several branch sewers which usually serve several hundred acres. It is then transferred to trunk sewers.

## **Trunk Sewers**

The large diameter pipes of trunk sewers are used to convey wastewater which is received from main sewers to either a treatment facility or interceptor line. As a town expands, it is possible to service newly-developed areas with trunk sewers to relieve the loadings on existing services.

## **Interceptor Sewers**

Interceptor sewers are usually quite large and receive flows from trunk sewers, which are then conveyed to treatment facilities.

## **Forcemains**

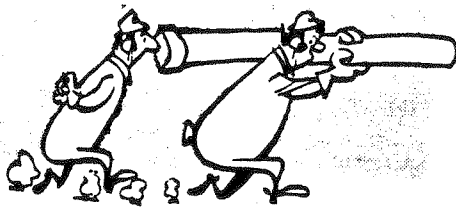

Forcemains are pipes made of either cast iron or polyvinylchloride pipe. They are used to transfer wastewater from the discharge side of a lift station to a point where it will flow by gravity.

## Materials Used

Sewer pipes are constructed of many different materials. The material used to make these pipes is selected for its strength, its ability to resist deterioration, and its ability to minimize infiltration and exfiltration. Listed below are some of the more common types of pipes used.

### **Asbestos Cement Pipe (ACP)**

Although asbestos cement pipe (ACP) is not common, it has occasionally been used. These pipes can be characterized by their water-tightness and their ability to resist abrasion and deterioration by most wastewater. The major problem with this pipe is its inability to resist corrosion caused by acid formed from hydrogen sulfide gas. It should not be used in places where this type of gas can be released.

### **Cast and Ductile Iron Pipe (CIP and DIP)**

Pipes normally used for forcemains and creek and bridge crossings are cast or ductile iron pipes. Because of their ability to resist crushing by heavy surface and earth

loadings, they can be used in shallow trenches under streets where the traffic loads are heavy.

**Polyvinylchloride Pipe  
(PVC) Chemical  
Resistant**

Polyvinylchloride pipe (PVC) is flexible and resistant to most chemicals found in wastewater. Occasionally, this type of pipe has been used in forcemain construction.

**Reinforced and  
Nonreinforced  
Concrete Pipe**

Concrete pipe is used extensively in the construction of storm water collection systems and for larger trunk and interceptor sewers in the sanitary collection systems. The inside of the pipe is sometimes coated with materials which will resist any corrosive action caused by acids found in or formed by wastewater.

**Vitrified Clay Pipe  
(VCP)**

For years vitrified clay pipe (VCP) was used extensively in the construction of lateral and main sewers. The PVC pipe, however, is gradually taking its place in modern day construction. VCP will usually resist the acids, alkalis, gases and solvents which can be found in wastewater.

**Manholes**

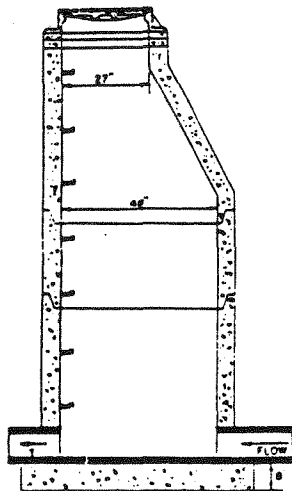

Manholes are constructed to allow workers and equipment access to the sewer for cleaning and inspection purposes. They should have a diameter of at least 48 inches and be located at the end of each line, at all changes in grade, size or alignment, and intersections. The distances between manholes should not exceed 400 feet for sewers less than 15 inches and 500 feet for sewers over 18 inches.

Lift Stations

Lift stations are placed in collection systems when wastewater can no longer flow by gravity. A lift station pumps wastewater to a higher elevation where gravity can be used again. Listed below is a brief description of the three types of lift stations in use today.



### **Pneumatic Ejectors**

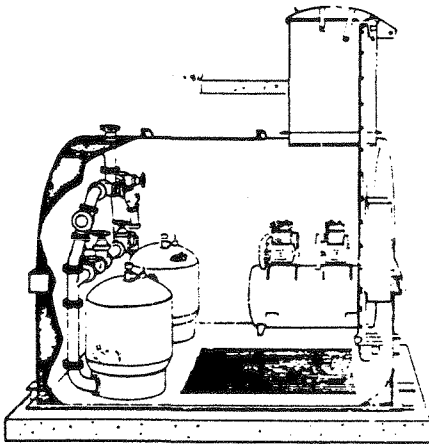

The pneumatic ejector type of lift station is used for small flows of less than 100 GPM and low heads. The flow is admitted through an inward-swinging check valve to the bottom of an airtight pot. As the water fills to a certain level, a signal is released to admit compressed air to a pot above the water. The wastewater is then discharged through an outward-swinging check valve. Lift stations of this type are virtually maintenance free, but the chamber (pot) is susceptible to corrosion caused by acids found and formed in wastewater.

### **Submersible Pump**

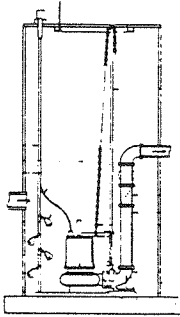

The centrifugal pump and motor used in submersible lift stations are completely submerged in the wet well. The pump and motor are a watertight unit which is usually controlled by teardrop-shaped plastic floats which have mercury switches inside them. This type of lift station is used with flows of 600 GPM or less, and requires minimal maintenance.

### **Wet Well/Dry Well**

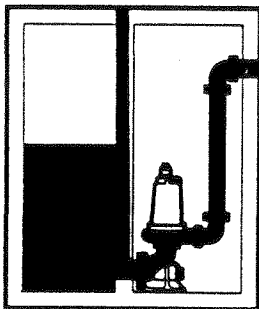

In the wet well/dry well pumping station, pumps are located in a separate chamber (dry well) with individual suction pipes submersed in the wet well. Pumps are usually controlled by an air-bubbler pipe, an electronic sensing device, or by teardrop-shaped plastic floats. It is important that the dry well be dehumidified and well ventilated to protect equipment and to ensure the safety of the operator.

### **Practice**

#### **Preventive**

#### **Maintenance**

### OPERATION AND MAINTENANCE OF COLLECTION SYSTEMS

Daily maintenance and inspection of a collection system is not just something to think about -- it is something which must be done! In the past, collection system

maintenance was done on an emergency basis only. It has been proven that a planned operation and preventive maintenance program will increase the life of a system, will save taxpayer's money and will also make an operator's job easier.

### Pipeline Maintenance and Inspection

What should be done to ensure that your system will continue to operate smoothly without blockages and disruptive service? The following methods should help in operating and maintaining your collection system.

#### Maps

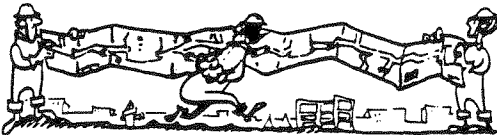

- 1) The location of all lines should be clearly shown on readily available maps.
- 2) All lines should be accessible and rights-of-way cleared.
- 3) Construction materials should be of good quality and construction inspection should be done by a qualified inspector.
- 4) Manhole spacing should dictate the length of cable sin any cleaning device.
- 5) Proper preventive maintenance procedures should be established to include routine inspection and cleaning of a collection system.

#### Preventive Maintenance



6) One-tenth of the total line mileage requires half of the total maintenance effort. Sufficient equipment and personnel must be available so these troublesome areas can be cleaned often.

### Inspection



7) Continuous inspection for illegal connections and discharges should be made.

8) The origin of all inspection and maintenance operations should be the point of discharge so that serious downstream blocks can be avoided.

9) Known breaks should be repaired prior to routine cleaning to avoid additional damage.

### Major Equipment

Depending on the size of your collection system, there is certain equipment which can be rented or purchased which will help with its operation and maintenance. Below is a brief description of some of the equipment in use today.

### Rodding Machine

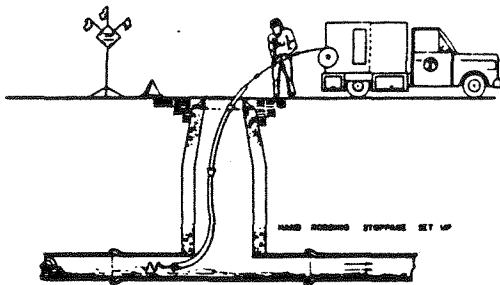

Rodding machines are fitted with steel rods which can be either pushed or pulled through the sewer. This method of cleaning is probably the most widely used. A special tool, such as an auger or root cutter, is placed on the end of a rod and allowed to rotate through the sewer, cutting its way through blockages of grease, roots or other debris.

#### WARNING

NEVER HANDLE THE ROD UNDER TENSION.  
TREAT RODS VERY CAREFULLY. THEY ARE  
VERY DANGEROUS.

## High Velocity Cleaner

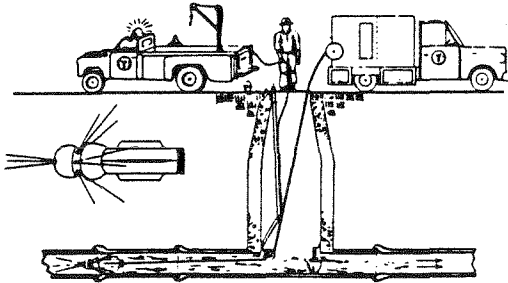

There is also the high velocity cleaner, also called *jet cleaner*, *jet rodder*, *hydraulic cleaner* and *high pressure cleaner*. It removes grease and debris from smaller diameter sewer lines using high velocity jets of water to scour through the line.

## Bucket Machine

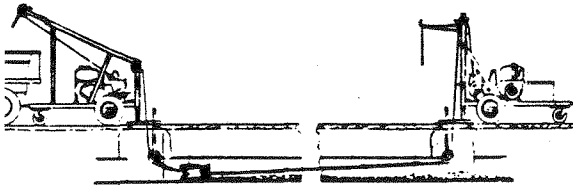

The bucket machine is a specially designed power which is placed over manholes and which controls the travel of buckets used to clean sewers. The buckets are pulled through the sewer and pick up settled debris as they go along. It has one open end and an opposite end to which a set of jaws is attached. The bucket is pulled through the sewer from the jaw end; this keeps the jaws open which pick up debris. When the bucket is full, it is pulled back through the sewer by the opposite end, which closes the jaws and retains the debris. Once removed from the manhole, the bucket contents are dumped into a truck. The process is repeated until the line is clear.

## Balling



Balling is a method of hydraulically cleaning sewer lines. The ball is restrained by a cable while water is allowed to wash past it at high velocity. The pressure of water creates a high-cleaning velocity around the ball. Sewer cleaning balls have an outside tread which causes them to spin, resulting in a scrubbing action against the walls of the pipe as water flows by.

## Inspection

Sewer lines are inspected by lamping or by using television or photographic equipment. Television and photographic equipment are expensive to use and are usually

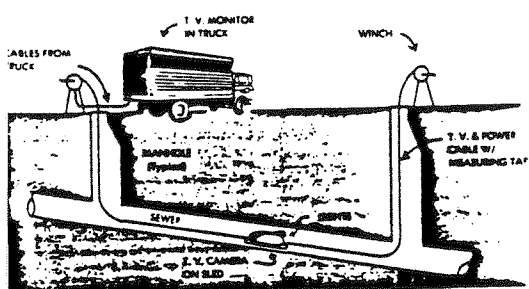

done on a contract basis. Lamping, on the other hand, is relatively simple. Reflected sunlight, or a powerful light, is directed down the sewer line from one manhole to the next. If it can be seen from the next manhole, it indicates that the line is straight and open and has no apparent blockage.

### Lift Station Operation and Maintenance

The pumps in a lift station convey pressurized wastewater to a treatment plant via a forcemain. Pumps in a lift station should be designed to allow an operator to maintain and repair equipment without taking the lift station out of service. Remember that all types of lift stations require daily inspection and should be included in a preventive maintenance schedule to avoid operational problems and breakdowns.



Maintenance of the lift stations entails the following:

- 1) General clean up;
- 2) Lubricating according to manufacturers' recommendations;
- 3) Checking the amount of pumping time on each pump to ensure equal operating time;
- 4) Removing any debris which may accumulate in the wet well;

**Lubrication**

**Checking**

## Cleaning

- 5) Cleaning floats and electrodes;
- 6) Inspecting check valves.

### Bar Screen Hand Raked

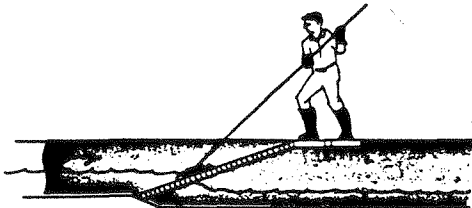

BAR SCREEN HAND RAKED

### Mechanically Cleaned Screen

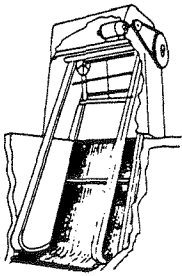

### Reduce Moisture Problems

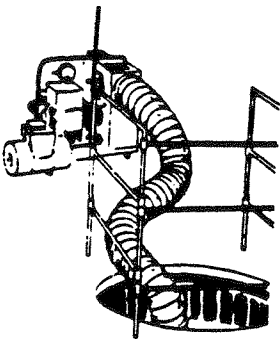

**For Safety's Sake --  
Ventilate!**

### Bar Screens and Baskets

Pumps handling raw wastewater should be preceded by a bar screen or basket with openings of approximately one-fourth to two inches. The purpose of these pretreatment devices is to protect pumps and valves and to reduce repair and replacement of treatment equipment.

Bar screen and basket cleaning should be included on a regular schedule so that the design function of this equipment is realized. This will also help to prevent clogging and possible sewer backup.

Screenings from bar screens and baskets should be stored and disposed of properly to eliminate odor problems. Final disposal is usually done by burial in a local landfill or by burning in proper incineration units.

### Dehumidifiers

Electrical controls, as well as other metal parts of the lift station, are subject to damage when exposed to excessive moisture. Moisture reduction within lift stations will appreciably reduce the corrosion problems. Dehumidifiers are often overlooked as effective moisture reducers for lift stations.

### Ventilation

Adequate ventilation should be provided in all lift stations in order to:

- 1) Avoid excessive air pressure or vacuum build-up above the wet well wastewater as it rises or falls;
- 2) Prevent the accumulation of explosive and lethal gases in the wet well.

When the pump station is below ground, mechanical ventilation is required to independently ventilate dry and wet wells.

#### Dry Well Dewatering

### **Sump Pump**

A separate sump pump should be placed in the dry well to remove leakage or drainage from the floor. Therefore, all dry well floor and walkway surfaces must have an adequate slope to drain to a sump pump collection point. The sump pump should discharge to the wet well at a point above the attainable water level.

#### Emergency Operation

During emergency lift station operations, it is necessary to protect public health by preventing discharge of raw wastewater to any state waters or from backup to basements, streets, or other public property. Providing an emergency power supply for lift stations may be accomplished by the following means:

- 1) Connecting the lift station to at least two independent public utility sources;

- 2) Providing portable or in-place internal combustion engine equipment which will generate electrical or mechanical energy;
- 3) Providing portable pumping equipment (standby power units should be placed in operation for a short period every two weeks to ensure the availability of emergency power.

### **Holding Basins**

### **Equalization Tank**

Another emergency measure which is occasionally taken involves using a holding basin. Flow can be retained for up to eight hours in one of these basins. When service has been restored, the basin's contents are fed into the wet well as pumping capacity permits.

### **Alarm Systems**



It is advisable that lift stations have alarm systems. The system would be activated in cases of power or pump failure, or for any other lift station malfunction. If possible, alarms should be telemetered to a central point which has 24-hour attendance.

Many of the difficulties in operating a lift station are caused by electrical systems. It would, therefore, help an operator to learn as much as possible about the functions of electrical systems.

### **Spare Parts Are Important!**

Lift station downtime can be minimized or avoided by carrying a reasonable supply of spare parts known to need occasional replacement. These parts should include bearings, seals, filters, packings and whatever else the manufacturer recommends.



## VELOCITY, FLOW MEASUREMENT AND RECORDING

Collection systems are designed to carry a specified quantity of water at a designated speed. When these design requirements are not met, it may cause problems within a system.

### Velocity

Sewers are designed to convey wastewater at a minimum velocity of two feet per second when flowing full. If the velocity is less than this, solids will settle in the line and may create a blockage. Problems also occur when the velocity is too high. Wastewater which flows too rapidly has a tendency to splash when forced to change directions in the sewer. This splashing allows release of odors and gases which can accelerate corrosion of concrete structures.

### **Measuring Velocities**

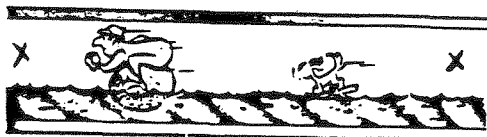

### **Dyes**

Since sewers are designed to accommodate peak flows, it is unreasonable to expect a minimum velocity of two feet per second at all times. Problems with sewer design, roots and other obstructions can reduce the velocity of wastewater. Through the uses of dyes or floats, an operator can measure velocity to make sure these problems do not exist.

Dyes are an effective means of estimating velocities. Drop a small amount of dye in the upstream manhole and record the total travel time it takes for the dye to be seen at the downstream manhole (Time 1); then, add the total time it takes to disappear (Time 2); calculate the velocity using this formula:

Time 1 (T1) = Time it takes dye to get to downstream manhole

Time 2 (T2) = Time it takes dye to leave downstream manhole.

Distance = Distance between upstream and downstream manhole.

$$\text{Velocity ft/sec.} = \frac{\text{Distance}}{(0.5) (T_1 + T_2)}$$

### Floats



Floats can also be used to determine velocities. Floats can be objects which are easily recognized such as an orange, ball or stick. The velocity is determined by recording the time it takes the float to travel a known distance and by using this formula:

$$\text{Velocity (ft/sec)} = \frac{0.85 \text{ to } 0.90 \times \text{Distance (ft)}}{\text{Time of Travel (sec)}}$$

NOTE: Friction against the walls of the sewer line decreases the velocity. Engineers have determined that most of the water flowing through a sewer has a velocity 85 to 90 percent of that of surface water. To calculate the average velocity of water in the sewer, we must reflect this difference in our formula by multiplying Distance/Time by 0.85 or 0.90. Use 0.90 for sewer pipes flowing at over 50 percent capacity and 0.85 for sewer pipes flowing under 50 percent capacity.

## Flow Measurement

Flow measurement is one of the most important parameters in wastewater collection and treatment systems. Many different types of flow measurement systems are available to fit a variety of applications. The two major application categories are open channel and closed conduit.

### **Open Channel Flow Measurement**

Open channel refers to flow in a stream, channel or partially filled pipe. Open channel flow measurement is used frequently in collection systems to monitor flows from different areas or from individual discharges. It is also frequently used to measure total wastewater treatment facility influent and/or effluent flow. Three examples of open channel type flow measurement are the Parshall flume, Palmer-Bowlus flume and sharp-crested weirs. The most common sharp crested weirs are V-notch and rectangular.

#### **Parshall Flume**

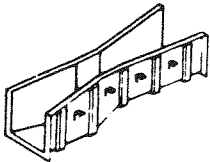

The Parshall flume is particularly suited to raw wastewater measurement because of its low head loss and self-cleaning ability. The Palmer-Bowlus flume has similar characteristics and has the advantage of being easily installed in existing sewer system manholes. Within a collection system, the use of sharp-crested weirs is usually limited to short-term flow metering. This is because solids, which build up immediately upstream of the weir, require frequent removal in order to maintain accuracy. Although actual weir installation is generally easy, a number of requirements must be met to insure accuracy. Anyone considering installing a weir should refer to a hydraulics textbook.

#### **Weirs**

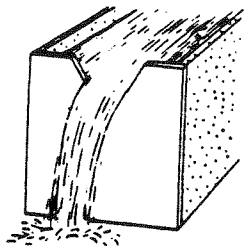

#### **Closed Conduit Flow Measurement**

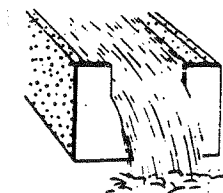

Closed conduit flow measurement refers to measurement in closed pipes under pressure such as lift

station force mains. Some common closed conduit meters are magnetic propeller, venturi tube, orifice and flow tubes.

The magnetic flow meter measures current generated by wastewater, or other flow media such as sludge, as it flows through a magnetic field in the meter. The current generated is in direct proportion to the flow rate through the meter. Propeller meters have a small propeller inside them which rotates at a speed directly proportional to the wastewater flow rate. Propeller meters can only be used to measure liquids low in solids. they are frequently used to measure effluent flow from wastewater treatment facilities. Venturi tube, orifice and flow tubes all measure pressure drop through the meter. The pressure drop is proportional to the flow rate. These meters are used in a variety of collection system and wastewater treatment facility applications.

### **Running Time Meters (Time Clock)**

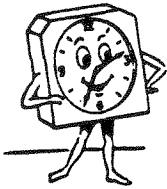

Another way to measure pumped wastewater flow is by the use of running time meters (RTMs) on pumps. Running time meters are low cost and can be installed relatively easily. Some operators have installed regular kitchen clocks to record the pump running times, but running time meters have the advantage of a continuous totalizer which can be used for recording and maintenance requirements. Recorded pump running times are multiplied times the respective actual pumping rates for each pump to obtain a total flow rate for the day. If two or more pumps run at the same time, a separate running time meter should be installed to record that time. It is emphasized that actual pumping rates must be used, NOT the pump nameplate ratings. The main disadvantage to pump running time meters is that they only

permit calculation of total flows unless strip chart event recorders are also installed. A strip chart event recorder provides a record of each pump's on-off cycling which can be used to evaluate flow rates at various times throughout the day.

### Flow Recorder

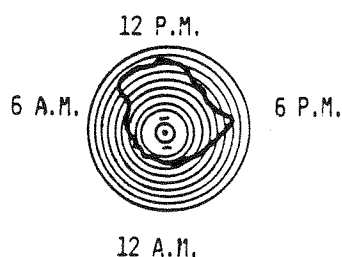

### Flow Recording

Flow recording devices are normally used in conjunction with open channel and closed conduit flow measurement. Recorders provide a continuous record of flow rates throughout the day. Recorder charts can be used by operators to evaluate daily flow variations and their impact upon the collection system or wastewater treatment facility. These charts can also be used for evaluating peak and low flow conditions over a period of years, providing a factual basis for determining inflow/ infiltration problems, industrial user charges and expansion needs.

### SAFETY

Safety in the wastewater field cannot be stressed enough. The wastewater field has the highest accident rate of any occupational field. You, the operator, have an obligation to protect not only yourself but your fellow workers and citizens from unnecessary risks. by following just a few basic safety rules while working on or in a collection system, you can save yourself a lot of time and grief.



### Traffic

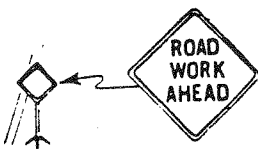

Make sure the proper traffic control equipment is used and that traffic can safely pass any area blocked off for maintenance work.

## Gas Hazards

The dangerous atmospheres found in collection systems can basically be described as those containing toxic or explosive gases and those lacking oxygen.

### Toxic Gases

One of the most dangerous and frequently encountered gases is hydrogen sulfide. This gas is generated by the anaerobic decomposition of organic matter in wastewater. It has a rotten egg odor and, because it is heavier than air, tends to concentrate near the bottom of enclosed areas. A major problem with hydrogen sulfide is that it tends to numb your sense of smell, making your nose an unreliable detector.



Other toxic gases found in collection systems include carbon monoxide, ammonia, chlorine and those resulting from industrial discharges.

### Explosive Gases

There are also many sources of explosive gases. Some of the more common include natural gas from a leaking main, gasoline washed into the sewer from streets or service stations, and methane generated in collection systems where anaerobic conditions exist.

### Use Gas Detector

Remember there is always the possibility of explosive gases! Just a lit cigarette, a spark from a passing car or a motor can set off an explosion.

Before entering a manhole or lift station where there are explosive gases, consult the fire department, gas company or other experts on the best way to clear the area.

**Oxygen Deficiency**  
**Monitor Oxygen Level**  
21% Normal  
19.5% Or less needs  
approved  
breathing  
apparatus

Our atmosphere contains approximately 21 percent oxygen. Humans can tolerate atmospheres containing a minimum of 13 percent oxygen. Any less oxygen could be fatal. When working in a manhole, an operator should try to maintain an oxygen level of at least 19.5 percent at all times

- 16% **Difficulty breathing, ringing ears, drowsy**
- 12% **Unconsciousness and DEATH!**

**Personal Hygiene**



**Manhole Safety**

**Lift Station Safety**

**First Aid -- Know How!**



(ventilation should be used). It is essential to check for these conditions to ensure that you are entering a safe environment. Wastewater also carries many kinds of infectious organisms. Remember to protect yourself and your family by keeping your shots up to date, washing thoroughly after contact with wastewater and leaving your work clothes at work.

**WARNING**

**NEVER ALLOW ANYONE TO ENTER A MANHOLE UNTIL THE OXYGEN CONTENT OF THE MANHOLE HAS BEEN TESTED AS BETWEEN 19.5 AND 21 PERCENT OXYGEN.**

When working in a manhole, make sure it is properly ventilated and that there are at least two workers above ground to assist you in case of trouble. Always wear the proper safety equipment -- a hard hat and safety harness.

Lift stations can contain the same gases as manholes; therefore, they must also be well-ventilated. Make certain that all controls are locked out when working on mechanical equipment, and do not work on the inside of a control panel unless you are a qualified electrician.

First aid is an important skill and could save someone's life. At least one person on a collection system crew should be qualified in basic first aid.

Many people can go through the motions required of a collection systems operator. But to be a good operator, you must recognize your responsibility to yourself, your coworkers, your community and your facility. Through

proper training, safety programs, and experience, you can successfully carry out this responsibility.

**S** SANENESS, COMMON SENSE, SUSPICIOUS OF TROUBLE  
**A** ALWAYS ALERTNESS  
**F** FIRST  
**E** EFFORT  
**T** THINK  
**Y** YOU



**ACCIDENTS DON'T JUST HAPPEN...  
THEY ARE CAUSED!**



## REFERENCES

1. Operation of Wastewater Treatment Plants, MOP No. 11, Water Pollution Control Federation.
2. Manual of Wastewater Operations, Texas Water Utilities Association.
3. Sewer Maintenance, MOP No. 7, Water Pollution Control Federation.
4. Wastewater Plant Operators Manual, State of Washington.
5. Operation and Maintenance of Wastewater Collection Systems, California State University, Sacramento.

# INTRODUCTION TO WASTEWATER

## TABLE OF CONTENTS

	<u>PAGES</u>
<u>BASIC WASTEWATER TERMS</u>	24
<u>OVERVIEW OF WASTEWATER TREATMENT</u>	27
Reasons for Treatment Stream Self-Purification	
<u>WASTEWATER TREATMENT PROCESSES</u>	28
Preliminary Treatment Primary Treatment Secondary Treatment Disinfection Tertiary/Advanced Treatment Solids Treatment Handling	
<u>CHARACTERISTICS OF WASTEWATER</u>	34
Physical Characteristics Chemical Characteristics Characteristics Commonly Measured	
<u>MICROBIOLOGY</u>	38
Biology and Biochemical Processes	
<u>REFERENCES</u>	44

## BASIC WASTEWATER TERMS

The following terms are commonly used when talking about wastewater treatment. A complete glossary is included as Appendix A of this manual.

### RAW WASTEWATER

Refers to the untreated, used water and materials discharged from community or industrial sources to the treatment facility.

### INFLUENT

Wastewater and material entering a treatment facility or unit.

### EFFLUENT

Wastewater or other liquid flowing out of a treatment facility or unit. Usually the effluent from a particular source in the treatment process is designated primary, secondary or final effluent.

### INFILTRATION

Ground water which enters a collection system through breaks, defective joints or porous walls.

### INFLOW

Storm water discharged into a collection system from such sources as roof leaders, foundation drains, catch basins, etc.

### BIOCHEMICAL OXYGEN DEMAND (BOD)

The rate at which organisms use oxygen while stabilizing organic matter under aerobic conditions. It is also a way of determining the amount of organic or biodegradable matter in wastewater. The BOD test is conducted at 20°C for five days.

### TOTAL SOLIDS

The total organic and inorganic material in wastewater which is measured as total dissolved solids and total suspended solids (TSS). This material is usually 0.1 percent of raw wastewater.

### DISSOLVED OXYGEN (DO)

Free or chemically uncombined oxygen dissolved in water or other liquid solutions. Dissolved oxygen is usually expressed in milligrams per liter (mg/l).

### BACTERIA

Organisms which are typically found in wastewater have biological requirements similar to animals. Bacteria use organic matter for their food and produce waste products. They occur in single-celled, filamentous, or colony forms. In wastewater treatment we refer to three bacteria types:

Aerobic Bacteria - Use dissolved or free oxygen for respiration.

Anaerobic Bacteria - Live in an environment containing dissolved or free oxygen. Use combined oxygen

(oxygen which is chemically combined or a part of another molecule, such as sulfate (SO<sub>4</sub>) for respiration.

Facultative Bacteria - Are able to use either free or combined oxygen.

### PATHOGENS

Organisms which can cause diseases such as typhoid, cholera, and dysentery.

### COLIFORM GROUP

A group of bacteria which inhabit the intestinal tract of man or warm-blooded animals, but may also be found in plants, soil, air and aquatic environments.

### FECAL COLIFORM

An organism which comes from the intestine of warm-blooded animals and is used to **indicate** the possible presence of pathogens in wastewater.

### POPULATION EQUIVALENT (PE)

A means of expressing a wastewater's characteristics in terms of number of people. It is used to compare characteristics of wastewater to those of normal domestic wastewater from a given number of people. Calculation of population equivalent assumes that one person contributes 100 gallons of wastewater per day, 0.17 pounds of BOD per day and 0.2 pounds of TSS per day.

## ALGAE

One or many-celled primitive plants usually aquatic and capable of growth on mineral materials. The green coloring material in algae, chlorophyll, absorbs energy from the sun and triggers photosynthesis -- the process by which the algae feeds itself and produces oxygen.

## OVERVIEW OF WASTEWATER TREATMENT

### Reasons for Treatment

The primary purpose of wastewater treatment is to protect the health and well-being of your community. The objectives of wastewater treatment include: prevention of disease and nuisance conditions; avoidance of contamination of water supplies and navigable waters; maintenance of clean water for survival of fish, bathing and recreation; and generally conservation of water for all uses.

Wastewater treatment is the process by which solids in the wastewater are partially removed and changed from complex, organic solids to minerals or relatively stable organic solids.

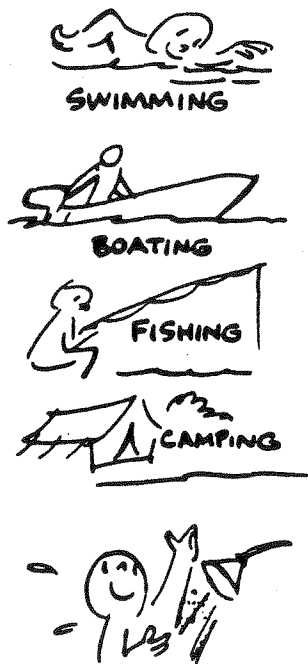

### **Stream Self-Purification**

### Stream Self-Purification

Self-purification is the natural ability of water to reduce bacterial content, to largely satisfy the BOD requirements of wastewater, to stabilize organic material, and to return dissolved oxygen to normal levels. This process occurs in several overlapping zones within a given body of water.

The zone of degradation is directly below the discharge point. Normally, there is visible evidence of pollution

### **Zone of Degradation**



around the discharge point. For instance, sludge bank formation and a decrease in fish life may be observed.

### Zone of Decomposition



### Zone of Recovery

The zone of decomposition is characterized by anaerobic decomposition or putrefaction (septic condition). However, if the volume of sewage is small compared to the stream's volume, the oxygen may not be depleted and this zone may not exist.

The zone of recovery occurs with the reappearance of aerobic bacteria species, fish and other higher organisms.

### Zone of Clean Water

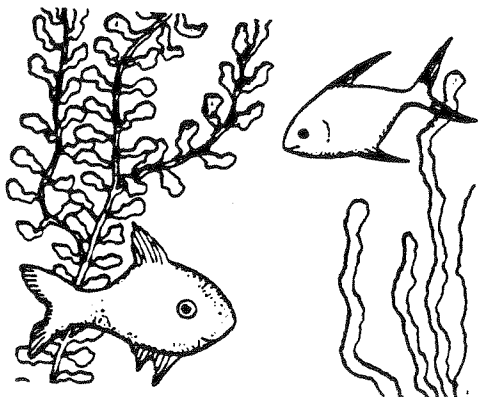

The zone of clean water occurs when the quality of the stream is back to the original state or better than it was at the discharge point.

By providing a wastewater treatment facility, we are allowing the self-purifying ability of water to occur under controlled conditions. If a wastewater treatment facility was not provided, this purification process would occur naturally in a pond, lake or several miles of rapidly flowing stream. By providing a wastewater treatment facility, the degradation and pollution of these waters can be prevented.

## WASTEWATER TREATMENT PROCESSES

There are many different types of wastewater treatment facilities when you consider the different combination of processes which are used to treat wastewater.

The following is a general overview of these different processes, their purpose, and mechanisms for providing treatment.

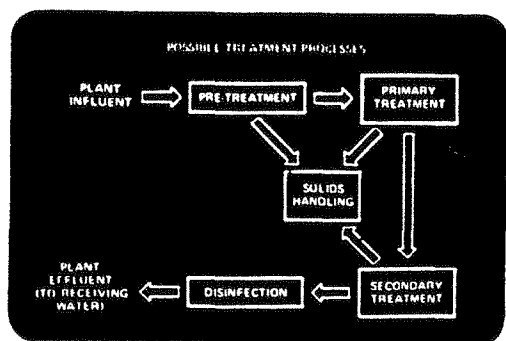

## Preliminary Treatment and Devices

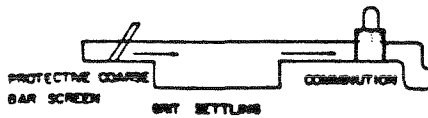

### Bar Screens

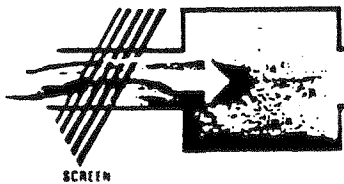

### Comminutors

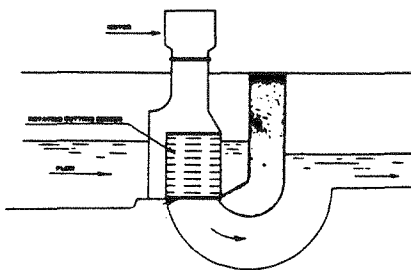

## Preliminary Treatment

The purpose of preliminary treatment is to remove from the wastewater some of the larger solids which can clog or damage pumps or interfere with subsequent treatment processes. Several types of preliminary units are bar screens, comminutors and grit chambers.

Bar screens provide for the removal of large rags, sticks or other debris which can be found in wastewater. They can be either mechanically or manually cleaned. Most bar screens found in small plants are manually cleaned. Manually cleaned bar screens are made up of several bars placed vertically in an influent channel. Screenings removed from bar screens should be free from any moisture and disposed of in a sanitary manner, either by burial in an approved landfill or incineration.

Comminuting devices such as grinders, cutters, and shredders, break or cut up solids so they can be returned to the sewage flow without causing damage to the treatment process or unit.

Comminutors are often used in conjunction with bar screens, either following or in parallel with the bar screen. In most small plants, the comminutor is placed in parallel with the bar screen. In this case, the bar screen is used only for emergencies or when work is being done on the comminutor. Comminutors are placed into the influent channel where wastewater can flow directly through the screen and cutter. As debris from the wastewater becomes caught on the screen, it is cut or shredded into very small particles.



## Grit Chambers

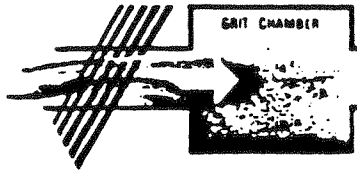

## Pre-Aeration

Grit chambers, although normally not found in smaller plants, are used to remove sand, silt and grit which can be found in the wastewater. This material is removed by slowing the wastewater down from a velocity of two feet per second to one foot per second. This slower velocity allows the heavier inorganic particles to settle out. Grit removal units should be cleaned on a regular basis.

Grease removal can also occur during preliminary treatment. The pre-aeration process is used for grease and oil removal, to freshen sewage, to supply DO and increase the settleability of solids in wastewater.

## Primary Treatment

Primary treatment is designed to remove organic and inorganic solids by the physical process of sedimentation. This is accomplished by reducing the velocity of wastewater enough to allow the solids to settle out. The units which allow water to slow down the solids to settle are clarifiers (also called settling tanks or sedimentation tanks), septic tanks, and/or Imhoff tanks. Primary treatment units are also used to remove floating solids such as grease, plastics, etc.

The removal efficiencies for these treatment units are approximately 90-95 percent for settleable solids, 40-60 percent for suspended solids and 25-30 percent for BOD.

## Primary Treatment Devices

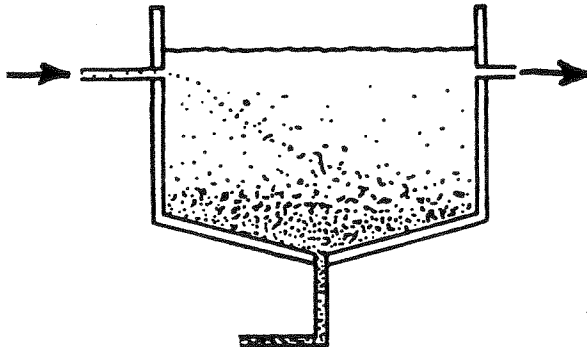

## Clarifiers - remove solids

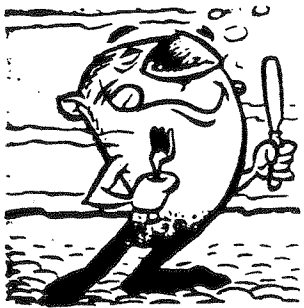
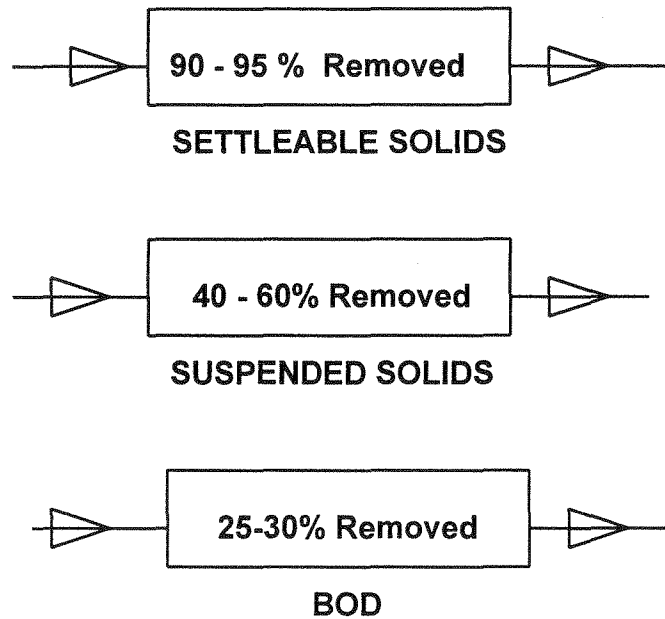

**Secondary Treatment -  
Removes BOD**

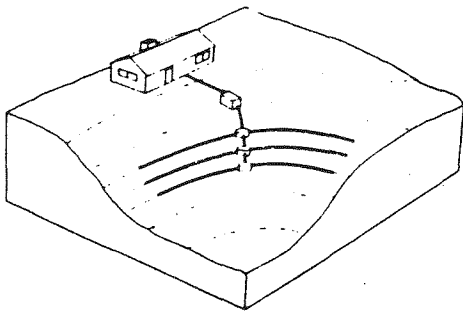

**Septic Tank/Soil  
Treatment System**

Secondary Treatment

Secondary treatment is used when wastewater has more organic solids in suspension or solution than the receiving water could accept if only primary treatment were used. Secondary treatment depends primarily on biological aerobic organisms to break down the organic solids in the wastewater, producing inorganic and stable organic solids.

These solids will then settle out and be removed. This process is comparable to the zone of recovery in a natural body of water. Examples of types of secondary treatment are septic tanks/soil treatment systems, trickling filters, rotating biological contactors (RBCs), activated sludge and stabilization ponds.

A septic tank removes most settleable solids. Micro-organisms decompose these solids. Septic tank effluent is discharged to a soil treatment system where additional

treatment of dissolved organic and inorganic solids and pathogens occurs.

### Trickling Filter

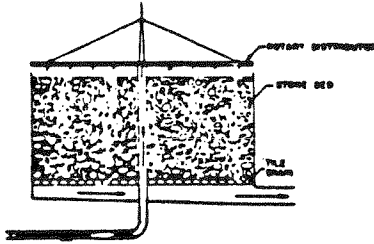

In a trickling filter (which is not a true filter, organic wastes (BOD) are broken down by the bacteria which live in a slime layer on the media. Oxygen is supplied to the bacteria from the natural flow of air between the rocks or filter media.

### Rotating Biological Contactor

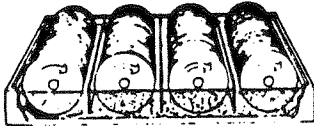

In Rotating Biological Contactors (RBCs), organic wastes are broken down by the bacteria which live in a slime layer on the media (disk). As the disk rotates, the organisms receive their food from the wastewater and their oxygen as it rotates through the air.

### Activated Sludge

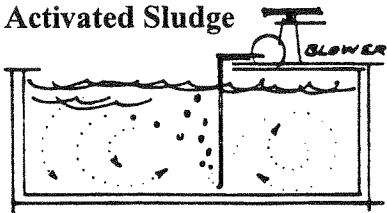

In an activated sludge process, the bacteria which live in the unit and break down the organic waste are suspended in the water. Oxygen is provided to bacteria by the aeration equipment within the unit.

### Stabilization Ponds

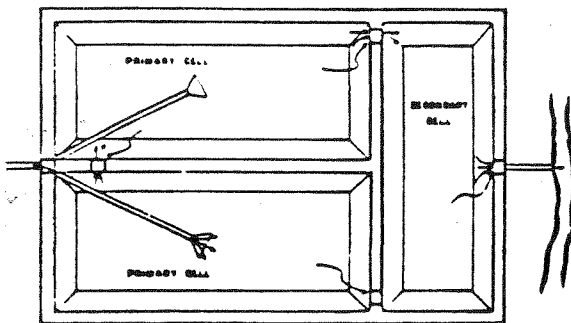

In the stabilization pond and aerated pond, bacteria which are suspended in water and live in the sludge break down the organic wastes. The oxygen in this process is provided by the algae which live in the water or, in the case of an aerated pond, by aeration equipment.

With activated sludge, ponds and RBC units you can expect 80-95 percent removal of BOD through proper operation. Septic tanks/soil treatment systems can remove essentially 99% of BOD.

### Disinfection

#### Disinfection

The words disinfection and sterilization do not mean the same thing in wastewater treatment. Sterilization means

to kill all organisms. It would be very costly and unnecessary to go to that extreme in the treatment of wastewater. Disinfection means the destruction of potentially harmful or pathogenic organisms; however, disinfection is not designed to kill all the organisms in a waste stream.

### Chlorine Contact Basin

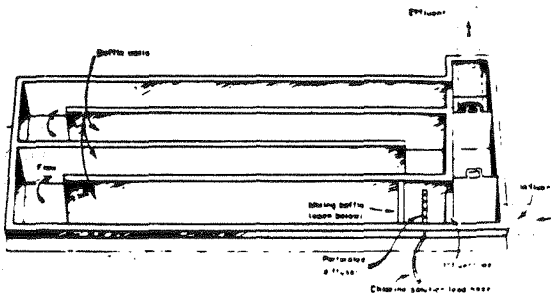

Chlorination is one form of disinfection. In the chlorine contact chamber, chlorine is mixed with the water and sufficient detention time (approximately 30 minutes) is provided to kill most of the disease-causing organisms.

There are other methods of disinfecting; for instance, the use of ozone and ultra-violet light. Ozone is a very unstable gas. It must be created at the site it is to be used. Once created at the site, it is to be used. Once created (by discharging an electric current in air), it is either injected or forced into the water. Ultra-violet (UV) is a form of radiation. The UV light is generated by a series of UV lamps which direct their light into the water.

### Tertiary/Advanced Treatment

#### Polishing Ponds

#### Effluent Filtration

#### Spray Irrigation

#### Chemical Addition

### Tertiary/Advanced Treatment

Tertiary or advanced treatment means any additional treatment following a conventional secondary treatment process for removal of nutrients or more BOD and TSS. Polishing ponds or effluent filtration are forms of tertiary/advanced treatment designed for further removal of BOD and TSS. Spray irrigation, or chemical addition on the other hand, are normally designed for nutrient removal.

## Solids/Treatment/Handling

### WHY DIGEST?

- Less sludge
- Less water
- Reduce odors
- Reduce pathogens
- Stabilize sludge

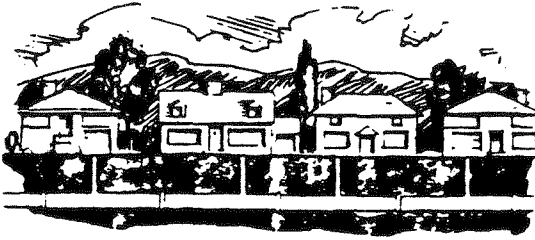

### Color Wastewater Grey

## Solids Treatment/Handling

Solids treatment/handling has two functions: 1) to reduce the volume of materials to be handled by removing some of the liquid portion; and 2) to decompose the highly organic matter to relatively stable or inert organic and inorganic compounds from which water will separate more readily.

Units which are incorporated in a facility to reduce volumes as well as decompose organic matter are digesters and sludge lagoons. Units generally used for dewatering or disposal are vacuum filters, drying beds, land disposal and incineration.

## CHARACTERISTICS OF WASTEWATER

### Physical Characteristics

Wastewater is basically the water supply of a community after it has been contaminated by various uses. There are many sources of wastewater including human and animal wastes, household wastes, infiltration of ground water, inflow of surface waters (storm water), and industrial wastes of various kinds. Physical characteristics can tell you a lot about the type of waste you are receiving at your facility as well as warn you of possible problems which may be developing.

For example, the color of normal domestic wastewater is grey, resembling dirty dishwater. A black color, on the other hand, may indicate septic conditions or certain types of industrial loading. Many color variations can occur and if the source and nature of the wastewater is known, this information can be used for operation of your facility.

## **Follow Your Nose**

Odors of fresh domestic wastewater are usually described as musty; whereas a rotten egg odor would indicate septic conditions in the collection system.

## **Not too hot**

**not too cold**

**but just right**

The normal effluent temperature of domestic wastewater is a few degrees warmer than the water supply of a community. Higher temperatures may indicate industrial cooling water discharges, whereas cooler water may indicate infiltration or inflow water.

## **What comes in -- goes**

**out, but how well?**

The flow variation in a community may be great, especially for smaller cities. The impact of this variation can cause severe problems in your plant.

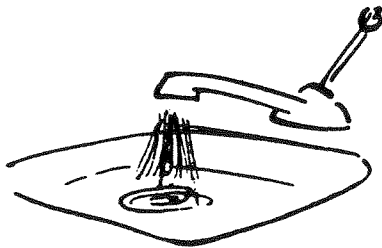

Wastewater is 99.9 percent water and 0.1 percent total solids. This 0.1 percent creates the need for wastewater treatment. An average of 0.5 pounds of total solids is contributed per person per day. Total solids include all solids in wastewater and can be broken down into suspended, dissolved and floating solids.

## **Total Suspended Solids**

Total suspended solids are visible and are in suspension in water. They are normally removed by the process of sedimentation or filtration. Normal domestic wastewater contains about 200 mg/l of suspended solids with each person contributing about 0.2 pounds per day to the wastewater stream. Suspended solids can be divided into settleable solids and colloidal solids.

## **Settleable Solids**

Settleable solids are those solids which are of sufficient weight and size to settle in a period of one hour. Primary clarifiers do most of the work removing settleable solids.

## **Colloidal Solids**

Colloidal solids are the solids which remain uniformly dispersed throughout the water and do not settle in a given period of time.

## **Dissolved Solids**

Dissolved solids are solids which are in solution (dissolved) in the wastewater. An example of a dissolved solid can be seen by dissolving a teaspoon of sugar in a glass of water. You cannot see the sugar as a solid, however, it is present in the water.

## **Floating Solids**

Floating solids are normally made up of oils, grease and fats and can usually be removed by a simple skimming process.

### Chemical Characteristics

**Where do they (solids)  
come from?**

Several different types of solids in wastewater can be divided into organic and inorganic compounds. Organic compounds can be considered solids which are made from animal or vegetable matter; for example, food, wood fibers or beer. Organic compounds are burnable, subject to bacterial decay, and constitute about 70 percent of the total solids load in a waste stream. Inorganic compounds are solids that are inert, that is, they do not originate from once-living substances; some examples are sand, glass and metal particles. Inorganic compounds generally cannot be burned and constitute about 30 percent of the total solids in wastewater.

## **Organic Compounds**

## **Inorganic Compounds**

### Characteristics Commonly Measured

**How do you figure out  
what you're treating?**

**pH**



**Is it acid or alkaline?**

There are numerous other physical characteristics which can affect wastewater treatment. It is important to measure some of these parameters to determine what actually composes the waste load and if proper treatment can be accomplished.

One commonly used parameter for determining waste characteristics is pH. The pH is a measure of the acidity or

alkalinity of a liquid and is measured on a scale from 0 to 14 with 7.0 being considered neutral. A pH of less than 7.0 is considered acid, and a pH of greater than 7.0 is considered alkaline. The pH concentration does have an effect on biological activity, and if the pH is within the range of six to nine, normal biological activity of the bacteria should not be affected.

**How much air (DO)  
is there?**

Another useful parameter is the dissolved oxygen (DO) concentration measurement. Dissolved oxygen is the oxygen which is trapped between water particles and is available for fish to breathe or for aerobic organisms to use.

**SOLUABILITY OF OXYGEN IN  
FRESH WATER**

°C	°F	O <sub>2</sub> (PPM)	°C	°F	O <sub>2</sub> (PPM)
0	32.0	14.6	26	78.8	8.2
1	33.8	14.1	26	78.8	8.2
2	35.6	13.8	28	82.4	7.9
3	37.4	13.5	29	84.2	7.9
4	39.2	13.1	30	86.0	7.6
5	41.0	12.8	31	87.8	7.5
6	42.8	12.5	32	89.6	7.4
7	44.6	12.2	33	91.4	7.3
8	40.4	11.9	34	93.2	7.2
9	48.2	11.6	35	95.0	7.1
10	50.0	11.3	36	96.8	7.0
11	51.8	11.1	37	98.6	6.9
12	53.6	10.8	38	100.4	6.8
13	55.4	10.6	39	102.2	6.7
14	57.1	10.4	40	104.0	6.6
15	59.0	10.2	41	105.8	6.5
16	60.8	10.0	42	107.6	6.4
17	61.6	9.7	43	109.4	6.3
18	64.4	9.5	44	111.2	6.2
19	66.2	9.4	45	113.0	6.1
20	68.0	9.2	46	114.8	6.0
21	69.8	9.0	47	116.6	5.9
22	71.6	8.8	48	118.4	5.8
23	73.4	8.7	49	120.2	5.7
24	75.2	8.5	50	122.0	5.6
25	77.0	8.4	51	123.8	5.5

At 0°C, the most oxygen which can be trapped between water particles (at sea level) is 14.6 mg/l. At 20°C, the most oxygen the water molecules can hold is about 9 mg/l. As water temperature rises, the ability of water to hold is about 9 mg/l. As water temperature rises, the ability to hold dissolved oxygen decreases. As the temperature of the water becomes lower, the ability of water to hold dissolved oxygen increases. If you know the oxygen-holding capacity of the water determined by its temperature, and know the DO value present after doing the DO test, it is possible to determine whether more oxygen can be added. Just remember, the farther the DO value is below the holding capacity value, the more oxygen you can add.

Dissolved oxygen can be added to water in several ways: by aeration equipment; turbulent flow or algae (in the case of a pond system). Whatever the mechanism, the need for dissolved oxygen is of major importance for good wastewater treatment.



**How much air do  
micro-organisms need?**

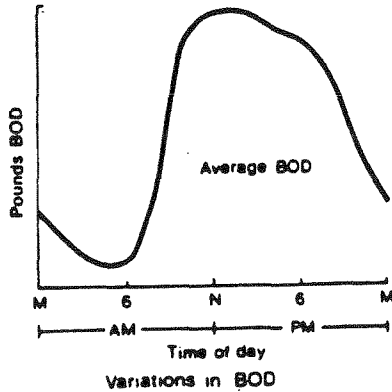

**Total Suspended Solids**

The amount of oxygen used for aerobic biological oxidation of organic solids is determined by the BOD test. BOD stands for *biochemical oxygen demand*, and is a measure of the amount of oxygen required for bacteria to decompose organic matter under aerobic conditions. Normal domestic wastewater contains about 200 to 250 mg/l of BOD. Each person contributes about 0.17 pounds per day to the waste stream. The BOD test, which is normally conducted for a period of five days in an incubator at 20°C, can be used to determine the efficiencies of your treatment facility.

Total suspended solids (TSS) are normally determined by the filtration method and as described previously, are solids which are visible and suspended in the water.

**Micro-organism**

**Population**

MICROBIOLOGY

The science of microbiology is concerned with the study of microscopic living organisms, including bacteria and algae. Microbiology and bacteriology are the foundations upon which most wastewater treatment processes are based.

**TYPICAL BACTERIA**



**Coccus**



**Bacillus**



**Spirillum**

Bacteria are minute, living organisms each consisting of a single cell. Because they can only be seen under a microscope, they are called micro-organisms. All bacteria require food and are affected by conditions of their environment. Like humans, they eat, respire, require moisture and heat, and can give off waste products. The most important factors influencing their growth are food and sufficient moisture to carry food into the cells.

## **Bacteria = Single Cell**

Food assimilation, waste excretion, respiration, growth and all other activities are carried on through the action of one single cell. Bacterial cells consist of an outer shell or membrane, an inner jelly-like material called protoplasm and a nucleus. Under optimum conditions, bacteria may divide and reproduce every 20 to 30 minutes. The increase in number of bacteria may be tremendous in a short period of time.

## **Growth Curve**

Bacteria grow and multiply in a very definite pattern called a growth curve. The design and operation of a treatment plant must take the growth curve into consideration and must provide an environment favorable to this growth.

Bacteria are found everywhere. They are present in water, dust, and soil. They are also present in the bodies of all living organisms, including man. Some of the bacteria which live within our bodies are essential because they help carry on many of our necessary life functions, particularly food digestion.

## **Workers (Saprophytes)**

Saprophytes are bacteria which can carry on an independent existence. They find their own food and are equipped to carry on all necessary life-sustaining functions.

Saprophytes normally obtain food from dead organic matter which they decompose and break down into simpler substances. This type of bacteria is responsible for the decay of most organic matter and is of utmost importance in wastewater treatment.

## **Dependent**

Symbiotic and parasitic bacteria cannot live an independent existence and must therefore remain in close association with some other living organisms from which they can obtain food. They are dependent upon the body of

the host for proper environmental conditions. They carry on decay and decomposition of a food supply, producing end products which are necessary for the nourishment of both themselves and the host. Parasitic bacteria are similar except that they produce end products which are not beneficial to the organisms in which they live.

### Harmful

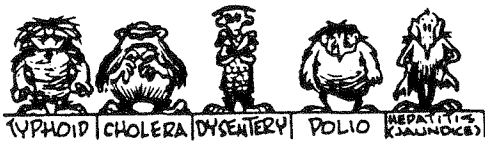

Pathogens are parasitic bacteria which produce end products which are poisonous to the host organism. These parasites produce a condition called disease. Some are pathogenic to humans only, others to certain types of warm-blooded animals and others to plants. A few saprophytic bacteria may also be pathogenic.

### Microscopic organisms

can be seen by the  
unaided eye

In addition to bacteria, other living organisms are commonly found in water and wastewater. Most are higher on the life scale than bacteria. They range in size from viruses so small they can only be seen with an electron microscope to much larger forms easily visible to the unaided eye.

### Virus

A virus is the smallest biological structure containing all the material necessary for its own reproduction. Viruses are parasites which require a host in which to live. Viruses do not play a part in treatment; however, like pathogenic bacteria, they can cause a number of diseases in people, such as hepatitis and polio.

### Algae

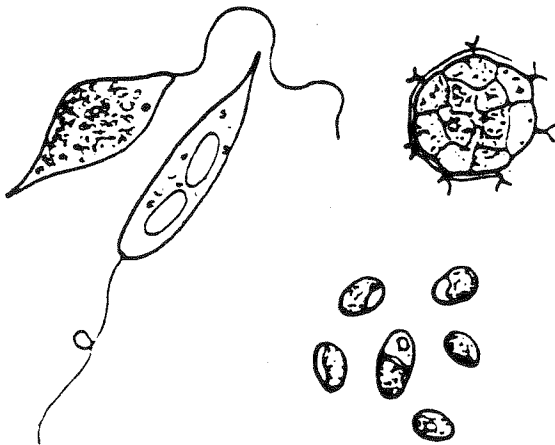

Algae are a very large group of single-celled plant forms distinguished by the fact that they contain chlorophyll - the green coloring matter of plants. Under the influence of sunlight, chlorophyll-bearing plants like algae can produce their own food from minerals through the process of photosynthesis.



Fungi are also plants, but in contrast to algae, they do not contain chlorophyll. They are filamentous-type organisms.

Fungi can grow under a wide variety of conditions and can tolerate an environment with a relatively low pH. Their ability to survive under low pH conditions makes them very important in the biological treatment of some industrial wastes.

### Protozoa

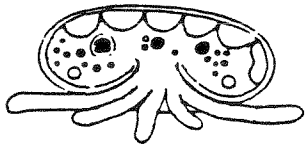

Protozoa are also single-celled organisms but are usually considered to be higher forms of life than algae. They are usually motile (self-propelled) and are somewhat larger than bacteria. Protozoa are predators which feed on other microscopic organisms, primarily bacteria. There are thousands of varieties ranging in size from submicroscopic to some which can be seen with the naked eye.

One of the most important types of protozoa found in any secondary treatment process are the ciliates.

### Ciliates

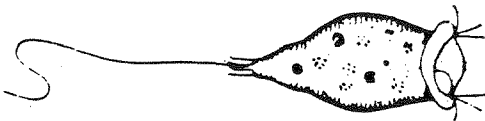

Ciliates are organisms which have short hair-like appendages called cilia which extend from the body around the entire cell margin or which may only be present at the anterior (forward) end. The ciliate group is comprised of both free-swimming and attached stalked forms.

Ciliate protozoa consume huge numbers of bacteria and help to keep the biological system in balance.

### Rotifers

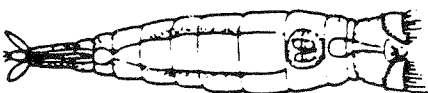

Rotifers have cilia which rotate like wheels. They are present in a condition of very low BOD loading and high efficiency, indicating an approach toward total oxidation.

## Biology and Biochemical Processes

The life activities of micro-organisms in wastewater produce changes in the chemical composition of wastewater called biochemical changes.

The biological oxidation of waste substances by aerobic micro-organisms in wastewater can be compared to human metabolism. In humans, food is absorbed through the intestine. A portion is then oxidized to supply energy, and the remainder is synthesized into new tissue. The energy maintains body heat and provides for muscle work and other life functions.



Likewise, micro-organisms synthesize (bring together and convert) and oxidize (burn up) foodstuffs contained in wastewater. This is a three-phase process. A portion of the removed organic matter is oxidized, and a portion is synthesized into new cell material. Ultimately, this new cell material is also oxidized. The overall biochemical reaction may be illustrated by the following equation:

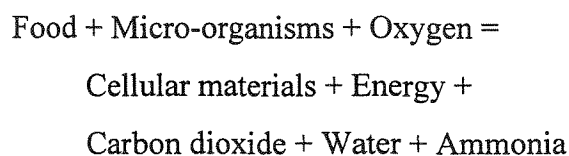

**Oxidation = aerobic  
decomposition in the  
presence of oxygen**

It is primarily bacteria which cause the breakdown or organic matter into simpler substances. In the presence of oxygen, this aerobic bacterial decomposition is called oxidation. In the absence of oxygen, the anaerobic bacterial decomposition is called putrefaction.

**Putrefaction = anaerobic decomposition in the absence of oxygen**

BUCKY BACTERIA HOLDING ON TO OR  
ADSORBING ? ORGANIC  
MATTER

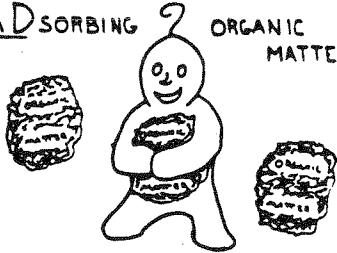

BUCKY AFTER HE HAS EATEN OR  
ABSORBED ? THE ORGANIC  
MATTER

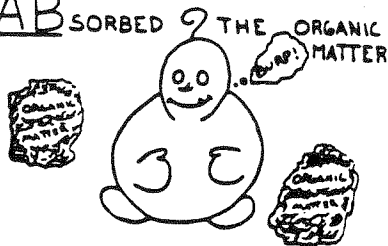

In aerobic decomposition, oxygen is combined with the elements contained in organic compounds (nitrogen, sulfur, phosphorus and hydrogen). In anaerobic decomposition, oxygen is removed from complex compounds to form simpler ones.

Dissolved organic solids are readily absorbed through the cell wall of micro-organisms. Bacterial decomposition is a very efficient way of treating wastewater because colloidal, or nonsettleable solids, are also affected by these biochemical changes. In the secondary treatment process, fine colloidal particles in the wastewater are trapped or adsorbed onto the slime layer surrounding the bacteria. This surface adsorption occurs almost immediately when the wastewater contacts the bacteria. Bacterial cells secrete enzymes (proteins which produce a chemical change without being used up themselves in the reaction) to act on suspended and colloidal solids. After this reaction, the finer solids are absorbed through the cell wall.

## REFERENCES

1. Operation of Wastewater Treatment Plants, California State University, Sacramento.
2. MOP 8 - Wastewater Treatment Plant Design, Water Pollution Control Federation.
3. MOP 11 - Operation of Wastewater Treatment Plants, Water Pollution Control Federation.
4. Trickling Filter Operation and Maintenance Manual, Minnesota Pollution Control Agency.
5. Aerobic Biological Wastewater Treatment Facilities, Office of Waster Programs Operations, U.S. Environmental Protection Agency.

# PRELIMINARY TREATMENT AND CLARIFICATION

## TABLE OF CONTENTS

	<u>PAGES</u>
<u>INTRODUCTION</u>	46
<u>PRELIMINARY TREATMENT</u>	46
Bar Screens	
Comminutors	
Grit Chambers	
<u>CLARIFICATION</u>	50
Theory	
Design	
Operation	
Maintenance	
<u>REFERENCE</u>	64



## INTRODUCTION

In this chapter we will discuss both preliminary treatment and clarification. In discussing clarification, most of the emphasis will be on primary clarifiers. It should be understood that most of what applies to final clarifiers also applies to final and intermediate clarifiers. Where there are differences, they will be pointed out. In the past, the terms *sedimentation* and *settling tank/basin* would have been used synonymously for the word clarifier. Since clarifier is the most commonly used term, we will use it throughout this chapter.

We will look first at the operation and maintenance of preliminary treatment units, followed by a more in-depth discussion of clarifiers.

## PRELIMINARY TREATMENT

The purpose of preliminary treatment is to protect equipment. Raw wastewater typically carries large, nondecomposable items (such as plastics, sticks, rags, rocks and grit). These materials, if allowed to flow through the plant, could cause operating problems by plugging pipes, pumps or valves or by damaging other equipment. Preliminary treatment units are installed to remove these objects.

There are basically three types of preliminary treatment devices which are bar screens, comminutors and grit chambers. Bar screens and comminutors are designed to remove or grind up large objects, while grit chambers remove inorganic solids normally called grit.

### **Preliminary Treatment**



### **Three Types**

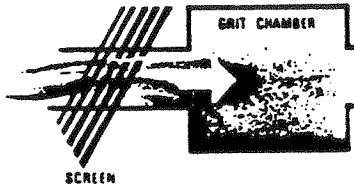

## Bar Screens

Bar screens and racks are designed to remove large, troublesome objects such as rags, plastics, sticks, scrap metal, household objects, trash and other material which might clog pumps or cause damage to other plant units. Screening systems are commonly called bar racks when the spacing between the bars is at least three or four inches. When the spacing is about one or two inches, they are usually called bar screens.

### **Hand Raked**

Hand raked bar screens are the simplest type of screening system; however, the use of a mechanical cleaning device with a bar screen tends to reduce labor costs and provide better flow conditions. Mechanical bar screens are used at most medium to large sized facilities.

### **Mechanical**

A build-up of materials on a bar screen promotes removal of smaller objects, and therefore better screening of raw wastewater. On the other hand, too much build-up will plug the screen openings and cause a damming effect which will lead to excessive water backup in the incoming sewer. The frequency of raking will be determined by experience and must be frequent enough to prevent surges of water through the treatment.

### **Dispose of**

### **Screenings**

### **Frequently**

Screenings do not normally contain a lot of decomposable materials; however, grease and other organic matter adhere to screening and can cause odor problems upon decomposition. Therefore, good housekeeping is especially important around bar screens. The area and machine should be thoroughly hosed down daily, and the screenings must be disposed of frequently. Prior to disposal of screenings, all moisture should be removed.

## Comminutors

Comminutors are devices which act as a cutter and a screen. Their purpose is to shred (comminute) the solids and leave them in the wastewater. A comminutor consists of a rotating drum with slots for wastewater to pass through. Cutting teeth are mounted in rows on the drum. As with screens, they are mounted in a channel and wastewater flows through them. The rags and trash in the wastewater are then shredded by cutters (teeth) until they can pass through the openings.

Pieces of wood and plastic are rejected and must be removed by hand. Some comminutors have a shallow pit in front of them to catch rocks and scrap metal. Periodically, the flow to a comminutor should be shut off and the debris removed from the trap.

There are several variations of comminutors. One of the most common ones has the trade name "barminutor." This unit travels up and down the screen. It is very important to maintain the oil level in these machines in order to prevent water from getting into the bearings.

The two most important elements of comminutor maintenance are sharpening and lubrication. If the cutters (or teeth) are not kept sharp, rags will be shredded to form long ribbons which can wrap around pumps and valves and cause further maintenance problems. Consult the manual or manufacturer for recommendations as to sharpening frequency. As with any piece of mechanical equipment, be sure to lubricate comminutors according to manufacturer's recommendations.

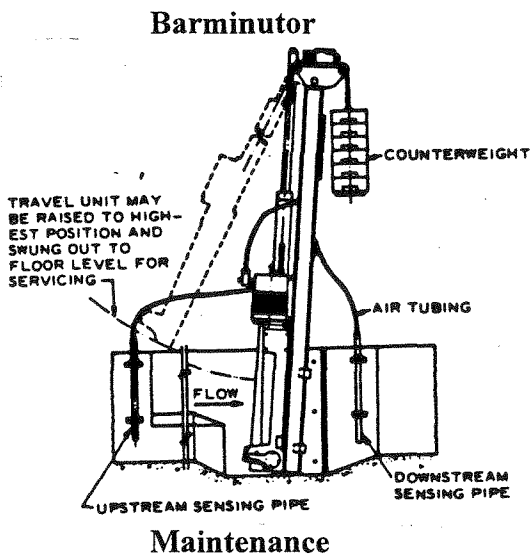

## Grit Chambers

Grit chambers are installed prior to sedimentation and usually after bar racks to remove dense inorganic matter such as sand, gravel, glass, egg shells or cinders. Grit removal helps prevent problems in pumping sludge. They are also installed to prevent reduction of active digester capacity and help prevent damage to mechanical equipment. Grit chambers are especially important in plants which have a combined storm water flow. In wet weather, and particularly with combined wastewater flow, the accumulation of grit may be enormously increased.

Hand cleaned grit chambers are often used in small treatment plants. They usually consist of two narrow channels with control devices at the outlet ends to provide a wastewater velocity of approximately one foot/second. Hand cleaned grit chambers are operated in parallel and when cleaned are alternated, allowing the flow to pass through one channel and then the other. The channel which is not in use is then manually emptied of all grit which has settled on the bottom or in the grit hopper. Cleaning grit chambers manually can be quite hazardous. Take precautions against slipping.

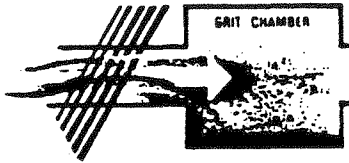

Mechanically cleaned grit chambers are usually rectangular tanks equipped with velocity control devices such as a parabolic flume or a proportional weir. Chain-and-flight mechanisms are used to move the grit to a sump or hopper. Square or circular tanks are also used. These units have circular collector mechanisms and are operated much like a clarifier.

The following items should be inspected regularly:

- 1) gates
- 2) bolts on flights and elevator buckets, chains and sprockets
- 3) flight shoes and rails
- 4) collector screws
- 5) shear pins

Quarterly, it is suggested that the tanks be drained and checked for:

- 1) loose bolts;
- 2) accumulation of debris in the tank and on air diffusers if it is an aerated grit chamber; and
- 3) excessive wear on screw conveyors or drive chains.

In addition, the tank should be thoroughly cleaned and inspected for general condition.

## **Cleaning**

Although grit is composed of mostly inorganic materials, it does contain some organic solids. If this material is permitted to accumulate in large quantities or for long periods of time, the decay of organic solids may result in significant odor and fly problems. During warm summer months, it may be desirable to dispose of grit daily. It is recommended that grit be disposed of at frequent intervals. Burial is the most satisfactory disposal method.

## **CLARIFICATION**

Clarifiers are used in two places in a wastewater treatment facility. A clarifier is used as a primary treatment unit before biological treatment processes and as part of or

following all secondary processes. Some plants have only primary treatment while others (especially extended aeration activated sludge plants), may not have primary treatment at all. All secondary biological processes (such as trickling filters and activated sludge) have a final clarifier, and some may have intermediate clarifiers as well.

### Theory

Clarifiers are designed to physically remove solids which will settle to the bottom of the tank or float on the surface of wastewater in the tank. A wastewater collection and treatment system can be thought of as a fast-moving creek with a pool in it. The collection system is like the narrow parts of a creek; flow is swift and solids are carried along with the flow. As water enters the pool, flow is slowed and a sand bar or pile of debris frequently occurs at the entrance. A clarifier works the same way.

By removing organic solids in a primary clarifier, the amount of BOD loading on the subsequent biological treatment process is reduced. Primary clarifiers are also important in removing grease and other floatable materials which can plug pumps, valves, filters and diffusers. Besides removal of solids, the primary clarifier also serves as an equalization basin to smooth out fluctuating organic loads at the facility. Primary clarifiers also may provide early warning of unusual wastes at the facility which may assist an operator in making process changes to protect the secondary units which follow.

### Design

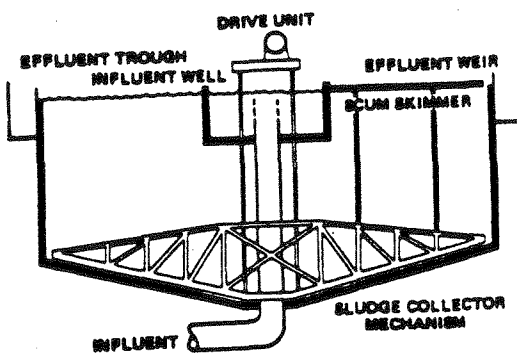

### Primary Clarifier

### Final Clarifier

Final clarifiers (and intermediate ones) are actually integral parts of the secondary treatment processes.

Remember that secondary treatment units (activated sludge, trickling filters, RBCs) are designed to remove BOD by converting BOD to settleable solids. These solids must be removed (in the final clarifier) to finish the job of secondary treatment and to protect a receiving water.

Final clarifiers, especially those for activated sludge plants, depend on flocculation. Flocculation is the process where small particles clump together with other small particles to form bigger particles which are heavy enough to settle out. A well-operated activated sludge plant will have active flocculating sludge.

### Design

#### Two Types

There are two types of clarifiers -- rectangular and circular. Both types operate on the same principles and have the same equipment, although they are shaped differently.

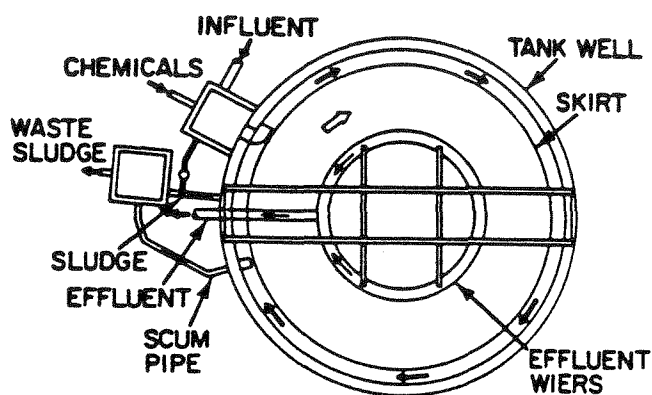

CIRCULAR CLARIFIER

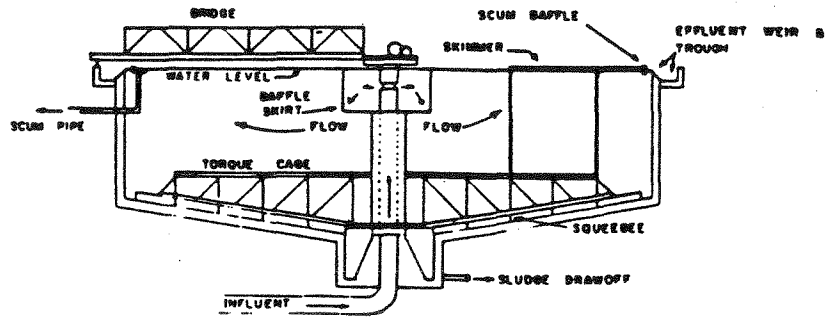

CIRCULAR CLARIFIER

The preceding two diagrams are of center-feed-rim-discharge circular clarifiers. Other common types of circular clarifiers are rim-feed-center discharge and rim-feed-rim-discharge.

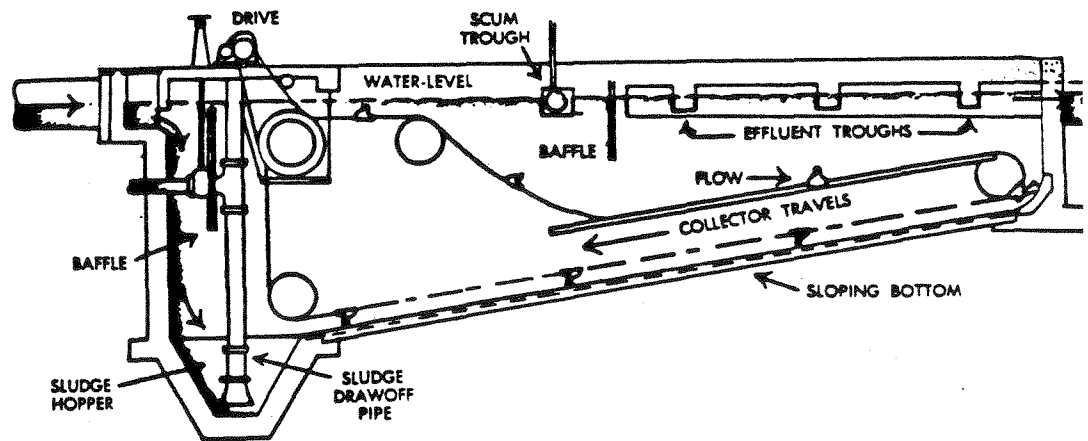

RECTANGULAR CLARIFIER

**Skimmer**

As the rake mechanism rotates, the settled sludge is pushed to a center hopper where it can be removed. The floatable material is moved to a skimmer by a surface blade attached to the sludge collector mechanism.



## **Chains and Flights**

In the rectangular type, wastewater flows from one end of the tank to the other and leaves over effluent weirs.

Settled sludge in most rectangular clarifiers is moved to a hopper (located at the inlet end) by wood flights mounted on parallel strands of conveyor chain. The chains and flights are carried on submerged sprockets, shafts and bearings, and are driven by a motor and speed reducer. As the flights travel along the bottom moving sludge to a hopper, they also usually travel in the opposite direction on the surface of the tank. This moves floating matter to a skimming mechanism which is located at the opposite end.

It is important that each of the flights in a rectangular clarifier are of the proper length. If the flights are too short, they will allow a build-up of solids on the outer edges which will turn septic and be discharged with the effluent from the tank. If a flight is too long, it may rub the tank wall and break the flight. If one flight breaks, it may wedge in a position which may result in the rest of the flights also breaking. Properly sized, each flight should have a clearance of from one to two inches between the end of the flight and the tank wall.

The settled sludge may be collected in a single hopper, multiple hoppers, or a transverse trench with a hopper at one end. The transverse trench may be equipped with a flight-and-chain collector or a screw conveyor to carry the sludge to a hopper.

Clarifiers are usually designed on three parameters -- detention time, surface settling rate and weir overflow rate.

**Detention Time =**

**Volume/Flow**

Detention time is the volume of the tank divided by the flow rate. Most clarifiers are designed to provide between two and four hours of detention time. However, longer detention times do not improve removals, but may actually be harmful by allowing the wastewater to become septic.

**Surface Settling Rate =**

**Flow/Area of Clarifier**

Another parameter is the surface settling rate, or the number of gallons applied to each square foot of the clarifier. Most clarifiers are designed between 600 and 1,000 gpd/sq. ft.

**Weir Overflow Rate =**

**Flow/Weir Length**

Clarifiers may also be designed on how fast the water flows over the effluent weirs. The number of linear feet of weir in relation to the flow is important to prevent short circuiting or high velocities near the weirs which may result in solids being carried over. Most of the time, the rate of flow over the weirs is designed to stay between 2,000 and 10,000 gpd/ft of weir.

**Inlet and Outlet**

**Structures**

Inlet and outlet structures, including appropriate baffles, play an important role in the efficiency of clarifiers. Inlets reduce the velocity of wastewater entering a clarifier and distribute the flow evenly through the cross section of the tank. Many inlet systems have been improperly designed, resulting in short circuiting through the clarifier.

**Short Circuiting**

As wastewater enters the clarifiers, it should be evenly dispersed across the entire width of the tank. If the velocity through the tank is greater in one area than in another, solids will pass more easily through the areas of higher velocity resulting in reduced clarifier efficiency. In effect, the short circuiting has reduced the detention time of particles in the clarifier, resulting in fewer of these particles settling out.

## **Currents**

Occasionally, in small clarifiers or clarifiers which are hydraulically overloaded, the movements of scrapers or flights can set up currents in the clarifier and cause sludge to be carried out of the clarifier. Consideration should be given to shutting off scrapers and clarifiers during high flow periods (for example when the main lift station turns on and there is a momentary increase in flows, or during the busy time of the day). Scrapers should not be left off for periods longer than an hour or so, or solids will build up and cause problems.

The design and construction of outlet baffles and weirs is also important to prevent short circuiting through the clarifier and to ensure adequate removal of floating solids. It is very important that the effluent weirs be level so the flow over each portion of each weir is the same. Most effluent weirs are constructed so they can be adjusted by an operator if leveling becomes necessary. If the weirs are not adjustable, an operator should install level plates along the top of the existing weirs.

## **Temperature**

The temperature of wastewater entering a clarifier influences the settling rate of particles in the tank. Water expands as temperature increases and contracts as temperature decreases. Because a decrease in temperature results in an increase in water density, the particles in wastewater settle less rapidly. At a water temperature of 80°F (27°C), the settling rate will be nearly 50 percent faster than at 50°F (10°C). The lower wastewater temperature during winter months usually results in lower removal efficiencies due to poorer settling characteristics.

Temperature differences between the tank contents and the incoming flow may also affect settling performance by setting up currents caused by differences in density.

### Operation

Operation of a clarifier consists mainly of removing solids, sludge and scum, and preventing short circuiting. Settleable solids and dissolved oxygen are two control tests which should be run daily to determine how many settleable solids are being removed. These tests will also help in checking the sludge to see if it has been sitting on the bottom of the clarifier and becoming septic. Occasionally, total suspended solids and pH are run to determine whether the influent wastewater has changed.

The following procedures should be used to ensure adequate clarifier operation.

- 1) Daily inspection of the tank is needed to be sure all mechanical equipment is in operable condition.
- 2) Frequent removal of accumulations from inlet baffles and effluent weirs is important. This may be accomplished by use of a broom, brush or high pressure hose.
- 3) Frequent cleaning of scum removal equipment should be done. This equipment is commonly a source of odors and unsightly appearance when neglected.
- 4) Hose down all wastewater and sludge spills as quickly as possible.
- 5) Record any unusual observations on the plant record sheet.

- 6) Sludge and scum removal should be done frequently (at least once daily).
- 7) Weir leveling should be done as required.

### Remove Sludge

#### Frequently



Sludge should be removed regularly. Most treatment plants have sludge pumps which operate either automatically or on timers to remove sludge. If sludge is allowed to remain in the bottom of a clarifier for too long, two things can happen. One, the volume of a clarifier is reduced because of the sludge blanket, reducing the detention time. Fewer solids settle out, and if any currents are generated (for example by the solids collection equipment), there is a greater likelihood that some of the settled sludge will be resuspended and washed out of the clarifier. Secondly, sludge which stays in the bottom of a clarifier may turn septic. This can result in foul odors in the clarifier, and in rising sludge clumps (carried up by gas bubbles generated in the septic sludge) being discharged over the weirs.

### Sludge Blanket

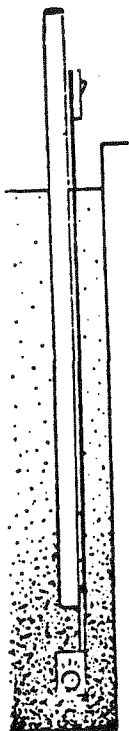

Normally, the sludge blanket in the bottom of a final clarifier, for an activated sludge facility, should be no more than 25 percent of the depth of a clarifier (a ten-foot deep clarifier should have a maximum of two and one-half feet of sludge in it). The sludge blanket can be measured in a number of ways. A clear plastic tube with a check or foot valve on the bottom can be used to take a "core" sample. A photo electric cell and light can also be lowered into the sludge blanket to determine the depth. For a trickling filter facility, very little if any sludge blanket is kept.

Leaving too much sludge in a clarifier can lead to the septic conditions described above. Too little sludge left in

the clarifier will not harm the clarifier, but it means that excess water is being sent to the solids handling unit.

### **Coning**

Withdrawal rates of sludge from clarifiers should be frequent and in small amounts. It should be slow enough to prevent coning of the sludge. If a cone is formed in the sludge blanket, only water will be pumped out. This will result in too much sludge being left in the clarifier and too much water being sent to solids handling. ON the other hand, pumping sludge too fast may result in a shock load on your sludge handling equipment.

If the sludge is being pumped directly to a digester, it is important to pump as thick a sludge as possible. The following methods can be used to be sure you are pumping as concentrated a sludge as possible.

### **Observations**

- 1) Make visual observations of a small quantity of sludge taken from a pump sampling tap. A good rule of thumb is to collect a sample of sludge being pumped and allow it to settle for ten minutes. If, after ten minutes, the sludge settles to less than 50 percent of the total volume, you have pumped too long. If the sludge has settled, but is more than 50 percent of the total volume, you should have pumped longer. With practice, an operator will soon learn to visually observe the sludge and determine whether to continue pumping or to stop.
  
- 2) Observe sludge being pumped through a sight glass installed in the discharge line of the sludge pump. Through experience and observation, an operator will be able to determine when pumping of the sludge can stop.

- 3) Because the sound of the sludge pump varies with the solids content of the sludge, many operators control pumping by the sound of the pump. This method, although better than none, is not a preferred method since many times the pumping is not stopped until the sludge is very thin and watery.
  
- 4) The pressure reading of the gauge on the pump's discharge piping will be greater when the sludge is thick. This method is not a good indication of sludge thickness because it is difficult to relate the pressure to the time when pumping should cease.

Operators have found that sludge particles sometimes adhere to the sloping sides of hopper walls instead of sliding into the hopper. These solids will turn septic and the resulting sludge gas formation causes the solids to rise to the surface of a clarifier. These floating clumps of sludge may be mistaken as a sign of inadequate sludge pumping. If the solids floating on the surface have risen from the side walls of a hopper, additional pumping times will be of no value to correct this problem. It may be necessary to squeegee the side walls of a hopper each time sludge is pumped from the clarifier. It may be possible to coat the side walls with some type of protective coating which will provide a smooth surface so the sludge cannot adhere. If this problem is frequent, it may be worth the time and expense to install piping down to the hopper area so water or air pressure can be used to remove sludge adhering to the walls. This water

or air pressure may also be helpful when sludge is difficult to remove due to high grit or sand content caused by infiltration problems.

### Maintenance

A good preventive maintenance program will reduce many problems which are common to clarifiers. This program should include the following:

#### **Records**

1) A good recordkeeping system should be used to note what work was done to each piece of equipment.

#### **Lubrication**

2) A lubrication schedule should be developed for each piece of equipment by referring to the manufacturer's recommendations for the equipment. At the time of lubrication, each unit should be examined for wear. Proper amounts of lubricants are essential to obtain maximum life from equipment. Overlubrication is just as poor a practice as not lubricating equipment frequently enough.

3) Each piece of equipment should be kept clean and well-painted at all times.

4) Inspect and correct all leaks, electrical systems, safety devices and peculiar noises.

5) Protective coatings applied to tall weirs, baffles and skimming mechanisms will protect these items from deterioration due to rust and corrosion.

#### **Shear Pins**

6) Be sure all shear pin mechanisms are operable to ensure minimal damage from overloading. It is not a good practice to have local machine shops make new shear pins unless they can make them from the same strength



of metal as the original pins. Pins larger and stronger than the originals should not be installed.

- 7) It is a good practice to completely empty each clarifier annually to visually inspect the structure and equipment.

The facility should have the following spare parts on hand so any required maintenance can be performed immediately.

### **Spare Parts**

- Wear shoes -- three percent of total in tank.
- Chain links and pins -- six per tank.
- Shear pins -- ten per tank.
- Flights -- one complete set.
- Drive chains -- one for each tank.
- Wiper blades -- one set for each tank.
- Skimmer assembly -- one for each tank.
- Motors, gear reducers and turntable gears should be kept on hand if possible. If stocking these items is not practical, the operator should know where each item is available should emergency maintenance work be necessary.

When the clarifier is empty, the chains should be inspected for wear. If necessary, remove links from each chain to achieve proper tension. Removing more than three or four links is abnormal. All collection chain links should be installed so the direction of travel is with the open end leading. Some manufacturers recommend flipping the chains and reversing the sprockets where possible to maximize the life of these items. This procedure may also prove useful to temporarily correct problems while waiting for delivery of

new parts. Also, when the clarifier is empty, the concrete should be inspected for deterioration and repaired if necessary.

## REFERENCES

1. Operation of Wastewater Treatment Plants, California State University, Sacramento.
2. Primary Treatment and Sludge Digestion Workshop, Ontario Ministry of the Environment.
3. Wastewater Engineering, Metcalf & Eddy, Inc.
4. Maintenance Mechanics, Deeds and Data Vol. 7, No. 7 Water Pollution Control Federation.
5. Trickling Filter Manual, Minnesota Pollution Control Agency.

# TRICKLING FILTERS

## TABLE OF CONTENTS

	<u>PAGES</u>
<u>INTRODUCTION</u>	66
<u>THEORY</u>	66
<u>DESIGN</u>	68
Distribution	
Media	
Underdrain	
Classification	
<u>OPERATION</u>	77
Series	
Parallel	
Recirculation	
Temperature	
Ventilation	
Loading	
Filter Flies (psychoda)	
<u>MAINTENANCE</u>	85
Distribution	
Media	
Underdrain	
<u>REFERENCES</u>	90

## INTRODUCTION

The first trickling filter was placed in operation in England in 1893. The first municipal trickling filter installation in the United States was constructed in Reading, Pennsylvania in 1908. In recent years, the activated sludge process has been used almost exclusively for plants treating wastewater from large cities, but there are still a large number of trickling filter facilities in operation throughout the United States today. Trickling filters have long been known for their rugged qualities and their ability to produce a high quality effluent under a variety of loading conditions.

## THEORY

A trickling filter consists of a bed of media material such as rock or tile, designed to provide a large surface area to which micro-organisms can adhere. Wastewater is sprayed over the surface of the bed, passes through, and is collected by the underdrains.

A trickling filter would be more aptly named a "biological oxidation bed" because a trickling filter does not depend upon the principle of straining which is associated with mechanical filtration.

As in other biological treatment processes, the trickling filter needs four requirements to fulfill this biological process.

Home -- the trickling filter

Food -- wastewater flowing over the media

Micro-organisms -- form a jelly-like slime on the media

### Trickling Filter Process

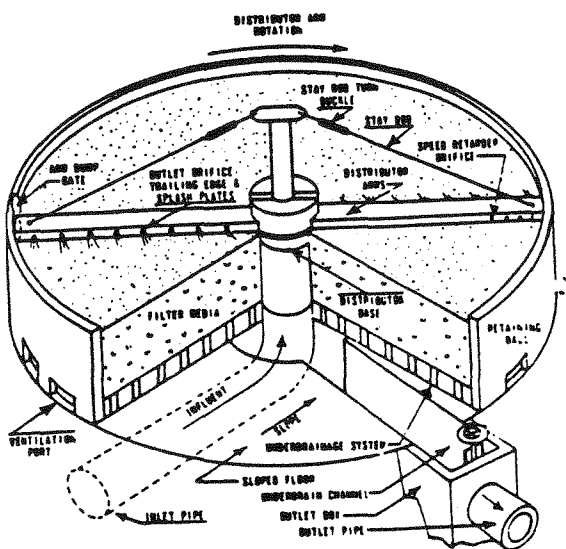

### Four Requirements

Oxygen -- needed by micro-organisms in the slime layer to maintain an aerobic condition.

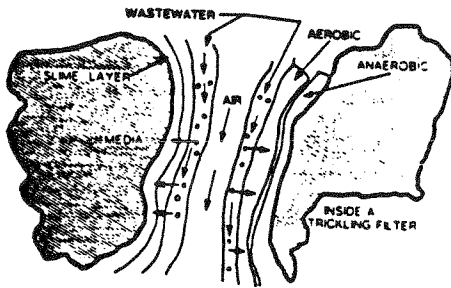

The removal of BOD in a filter is the result of a biological slime growth on the media. Micro-organisms adhering to the media surface form a jelly-like slime growth called biomass or zooglear film. The population of organisms thriving within the zooglear film include huge numbers of bacteria, many protozoans, rotifers, worms and insect larvae.

The trickling filter process is a secondary process which is used to convert nonsettleable substances (finely divided colloidal and dissolved solids) into settleable sludge. The organic material present in wastewater is eaten by an enormous population of micro-organisms attached to the filter media. It has been estimated that there are as many as 550,000,000 bacteria in one gram of biological film. As wastewater splashes over the media, organic material from the wastewater is adsorbed onto the biological film or slime layer. In the outer portions of the slime layer, the organic material is used as food by aerobic micro-organisms. Often, as the micro-organisms grow, the thickness of the slime layer increases and oxygen is consumed before it can penetrate the full depth of the slime layer. An anaerobic environment is therefore established near the surface of the media.

Aerobic organisms in the slime layer need oxygen to live. Air is constantly circulating through the trickling filter media which means the oxygen is constantly being dissolved. The aerobic micro-organisms then use this dissolved oxygen.

Natural air circulation through the trickling filter bed is accomplished by a “chimney” effect and is dependent upon temperature differentials between the atmosphere and the wastewater applied to the filter.

As the slime layer continues to increase in thickness, the adsorbed organic matter is used before it can reach the micro-organisms near the media surface. Without an adequate food source, the organisms nearest the media enter into an endogenous phase of growth. In this phase, the micro-organisms begin to die and lose their ability to cling to the media surface. The liquid then washes the slime off the media, and a new slime layer will start to grow. This phenomena of losing the slime layer is called “sloughing” and is primarily a function of organic and hydraulic loading on the filter.

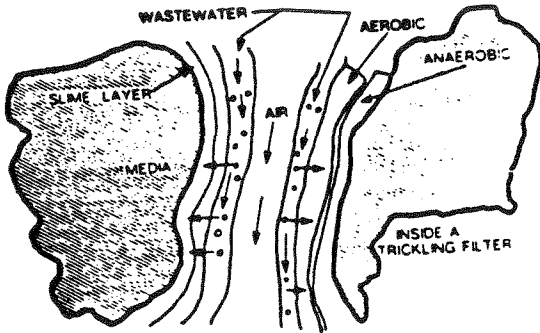

Normally, an equilibrium is reached where the sloughing of the zooglear mass approximately equals the new growth. Occasionally, however, the rate of sloughing greatly exceeds the growth rate. This phenomena is called “unloading” and often occurs simultaneously with seasonal weather changes.

## DESIGN

All trickling filters, regardless of classification, must have three basic components. They may be constructed differently or use different materials, but the basic principle is the same.

A trickling filter is an aerobic biological treatment process.

- 1) a distribution system;
- 2) a media (and retaining structure); and
- 3) an underdrain system.

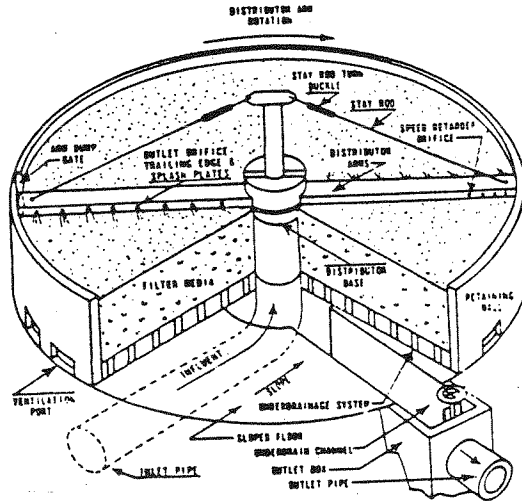

Most trickling filters are circular with the wastewater distributed over the top of the bed by a rotary distributor. Some older facilities are rectangular and the wastewater is applied through fixed spray nozzles at the surface.

### Distribution

The distribution system of a trickling filter is responsible for providing an even application of wastewater over the surface of the media. The two most common forms of distribution systems are fixed nozzle and rotary distribution. Other systems have used tip troughs or revolving discs to distribute the wastewater.

The motorized disc distribution system has been used in filters up to 35 feet in diameter. The system consists of a center column with a motor driven disc at the top. As water overflows at the top of the center column, it falls on the disc which is spinning. The “impeller” which is spinning, distributes wastewater over the surface of the media.

### **Most Common Types --**

**Fixed Nozzle and**

**Rotary**

### **Motorized Disc --**

**“Slinger” Type**



**Stationary --**

**Does not rotate!**

The fixed nozzle system was the first application system developed to be used with trickling filters. The advantages to the fixed nozzle arrangement are that they are rugged in construction, subject to little or no corrosion, and are easier than rotating mechanisms to manufacture and install. With these systems, however, the distribution of wastewater is not as even or continuous as with rotary systems.

**Rotary "Merry-Go-Round"**

**Type**

A rotary distributor consists of two or more horizontal arms attached to a vertical center column which rotates. Each arm contains a number of orifices or nozzles through which wastewater flows onto the media. Most rotary distributors turn by the jet-like action of the water discharging from the nozzles or orifices located on the side of the arms. Some rotary distribution systems have been designed to be driven by mechanical means, although the number of these units is limited.

**Center Columns**

Due to the number of suppliers which manufacture distributors for wastewater treatment, there are many variations in the design of these units. All units support the weight of the arms, wastewater, and the center column itself by using ball bearings or roller bearings. These bearings may be a source of problems to a trickling filter plant operator. The oil in the bearings should be checked frequently for signs of moisture or contamination. The oil should be changed if these conditions exist.

**Bearing Maintenance**

**Required**

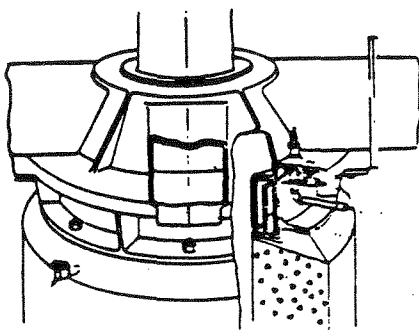

Originally, most distributors were provided with mercury seals to prevent leakage of wastewater into bearings. However, because mercury was found to be extremely toxic to living organisms, its use has been discontinued. This

problem arose when evidence was found that mercury was leaking out of the seal and ending up in a receiving stream. Since then, manufacturers have changed their products to have mechanical-type seals. Manufacturers have also designed conversion kits for existing mercury seals to change over to mechanical-type seals.

The problem with many conversions is that some leakage may still occur around the seal. This may not affect the performance of a facility, but if the column has ball bearings around the base, some of this leakage may enter them causing failure. Some operators accept this leakage, and the resulting bearing failure, as unavoidable and carry spare bearings and races on hand to replace them in case of failure.

**Keep Distributor  
Arms Adjusted**

To provide proper rotation, the distributor arm must be adjusted properly by use of support rods. The arms, when full of water, should be slightly lower at the outer ends than they are at the point they connect to the center column. To be sure all arms are at the same elevation, an operator should place a mark on the outside wall and measure from the mark to a point on each arm as it passes below the mark.

**Flushing Required**

The arms of a distributor should be flushed frequently, by opening the gates on the end of each arm, to prevent build-up of solids. These gates may need to be kept partially open in the winter to prevent ice build-up on the outer wall. If the arm has a drain hole at the outer end, be sure it remains open. This allows the arm to drain when there is no flow and prevents damage from freezing in cold weather.

## **Nozzles and Splash Plates**

Rotary distribution relies upon the flow of wastewater from the nozzles and splash plates. For this reason, it is very important to keep all nozzles clean and the splash pads properly positioned to provide uniform distribution. Uniform distribution of wastewater from the nozzles is important in order to effectively use all portions of the media for treatment. If poor distribution is apparent, an operator should find the reason and correct the problem.

## Media

The media in a trickling filter must provide surface area for biological growth along with sufficient void (open) spaces to allow adequate ventilation. The size of a trickling filter and size of media is dependent upon the applied hydraulic and organic loadings. High organic and low hydraulic loadings require larger media sizing to increase void spaces. The increased void space is necessary to prevent a condition known as ponding. Ponding may be caused by heavy biological growths which develop with high organic loadings.

## **Types of Material Used**

The media should be hard, durable, of uniform size and dimension, and free of fine particle material. If appropriate material is used during construction, it will minimize operational problems because it will not disintegrate under normal conditions. Media disintegration may occur due to freezing during extremely cold weather. The three most common materials in use are rock, tile and plastic.

### Rock

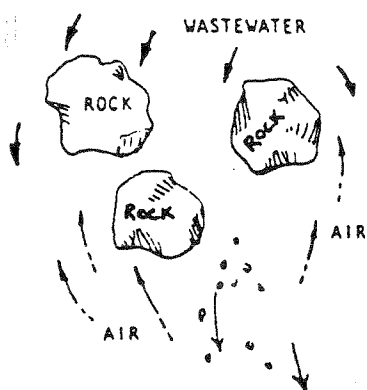

Rock media is the most widely used media in trickling filters. The depth of rock used at trickling filter plants vary from three to eight feet depending upon the design of a facility. It is important that the rock used in the filter is free of fine particles. To accomplish this, most specifications require a contractor to screen and wash the rock before placement in a filter. Uniform size of the rock is important to ensure sufficient voids to allow adequate ventilation through the media.

### Tile

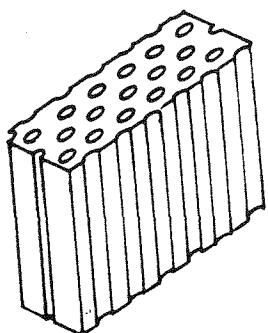

Tile media has been used in a number of trickling filters. In some facilities, tile media was installed in the first filter of a two-stage system with rock being used in the second filter. Tile has a higher percentage of surface area and void space than rock does and therefore should, under similar loads, resist ponding better than rock.

Manufacturers of tile media have claimed higher removal efficiencies with their product; however, studies have shown that there is a little difference in efficiencies of tile and rock media. Depths vary from three to eight feet depending upon the hydraulic and organic loadings applied to a filter and upon the recirculation scheme used at a facility.

### Plastic

#### Plastic

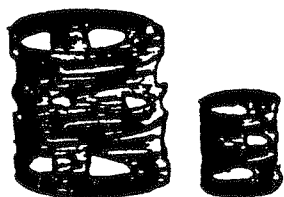

#### Light Weight

The development of plastic media has created new interest in the use of trickling filters as a biological treatment process. Because the new plastic media has a large surface area and a high percentage of void space, the use of this media allows much higher organic and hydraulic loading rates. The light weight and larger percentage of voids allows depths beyond that of rock and tile.

**5-20 Feet Deep**

**Forced Ventilation**

**Roughing Filters**

Plastic media filters have been built from 5 to 20 feet deep. Because of the depth used with plastic media, it is common to use forced ventilation to ensure an adequate supply of oxygen for the bacteria.

Plastic media filters are being used frequently as roughing filters to treat wastewater high in BOD before treatment by other biological processes such as activated sludge. The use of a trickling filter as a roughing filter smooths out loadings to the following activated sludge system.

Typical Trickling Filter  
Underdrain Blocks

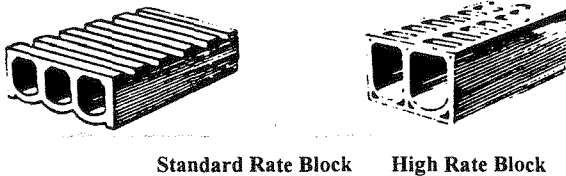

### Underdrain

The underdrain system in a trickling filter performs three basic functions. It:

- 1) supports the media;
- 2) permits adequate flow of oxygen through the filter media; and
- 3) collects wastewater after it has passed through the media so it can be routed to the following units.

The development and use of specifically designed underdrain blocks ensures adequate ventilation through a trickling filter. These blocks are usually made of vitrified clay with slotted tops which admit the wastewater and support the media. The underdrain blocks are laid directly on the filter floor, which is sloped toward a collection channel at a one to two percent grade.

## Natural Ventilation

To ensure adequate natural ventilation through a filter, it is important that underdrains flow no more than one-half full of wastewater. Air flow during winter weather is upward due to the wastewater temperature warming the air making it rise due to less density. During the summer, air flow is downwards because the cooler wastewater temperature cools the air making it more dense.

## Classification

The classification of trickling filters is based upon the hydraulic and organic loading applied to the filter. Further classifications designating single-stage, two-stage, series or parallel operation are used to indicate the flow pattern of the plant.

## Hydraulic Loading (gpd/ft<sup>2</sup>)

The hydraulic loading of a filter is the total volume of liquid, including recirculation, applied to the filter. Hydraulic loading is expressed as million gallons per acre of surface area per day (mgad) or as gallons per day per square foot of filter surface area (gpd/ft<sup>2</sup>).

## Organic Loading (lb BOD/day/1,000 ft<sup>3</sup>)

The organic loading applied to a trickling filter is expressed as pounds of BOD applied per day per 1,000 cubic feet of filter media (lb BOD/day/1,000 ft<sup>3</sup>). Recirculation does provide additional organic loading on the filter; however, this added loading is generally omitted because it is included in the influent load.

STANDARD-RATE FILTERS (also called low-rate or conventional-rate)

Hydraulic Loading  
(mgad) or (gpd/ft<sup>2</sup>)

1-4

Organic Loading (lb BOD/1,000 ft <sup>3</sup> )	5-25
Recirculation	None or very little
Filter Flies	Usually large number
Sloughing	Intermittent
Depth (ft)	6-8

#### HIGH-RATE FILTERS

Hydraulic Loading (mgad) or (gpad/ft <sup>2</sup> )	10-40
Organic Loading (lb BOD/1,000 ft <sup>3</sup> )	25-300
Recirculation	Usually
Filter Flies	Varies
Sloughing	Continuous
Depth (ft)	3-8

#### ROUGHING FILTERS

Hydraulic Loading (mgad) or (gpd/ft <sup>2</sup> )	60-80 (not including recirculation)
Organic Loading (lb BOD/1,000 ft <sup>3</sup> )	100 or greater
Recirculation	Varies
Filter Flies	Few
Sloughing	Continuous
Depth (ft)	3-20

## OPERATION

It is the responsibility of an operator to operate and maintain a treatment facility at all times. To accomplish this, excellent operation and maintenance records must be maintained and preventive maintenance practiced to a high degree. Another responsibility of an operator is to keep a daily operating log. The daily log should contain everything of interest such as volume, raw wastewater characteristics and overall plant efficiency. Flow and rainfall records should also be kept to indicate sources of unwanted infiltration. This information can be entered on the monthly operating report form which is submitted to the state regulatory agency.

Many plant operators also have the responsibility of preparing an annual report to be submitted to the city. This report should contain a summary of the past year's operation, a copy of last year's budget and actual expenditures, including recommendations for additions or corrections for the following year.

### Series

When the reference is made to a single stage trickling filter plant, it indicates that the facility has only one trickling filter. A two-stage trickling filter facility has two trickling filters operated in series. The wastewater flow is treated by one filter then flows through a second filter. The two filters may or may not be separated by a clarifier.



### Parallel

A trickling filter facility with two filters operated in parallel normally divides the flow into two parallel systems after preliminary treatment; each system having a primary clarifier, trickling filter and final clarifier. Depending upon the size of each of the two filters, the flow may or may not be divided equally among the two. This is not considered a two-stage filter.

The following flow diagrams illustrate single-stage, two-stage/series, and parallel flow trickling filter facilities.

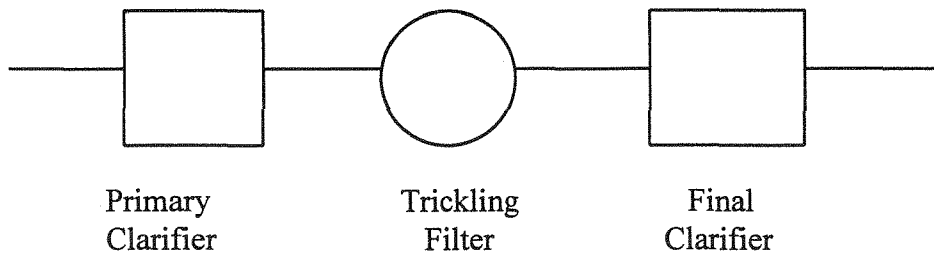

**SINGLE-STAGE TRICKLING FILTER**

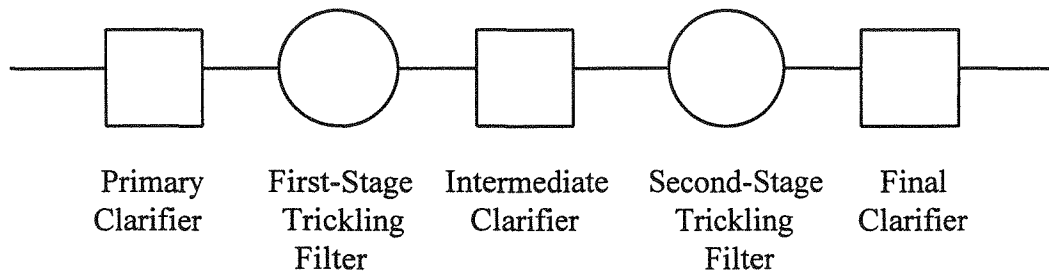

**TWO-STAGE/SERIES TRICKLING FILTER**

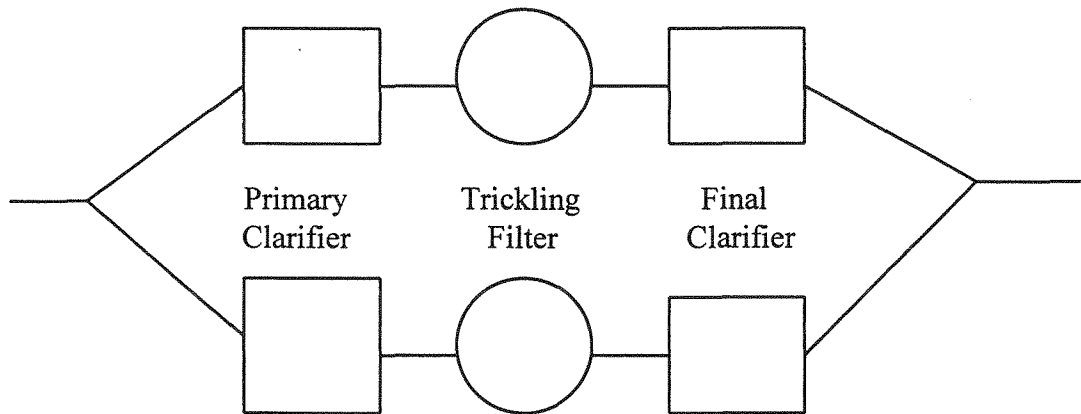

## PARALLEL FLOW TRICKLING FILTER

### Clarifier Needed for Solids Removal

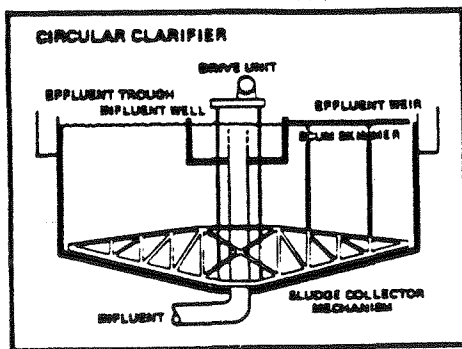

As in other secondary treatment processes, the clarifier is an important part of a trickling filter system. It is needed for removal of suspended solids which are sloughed off from the filter media. In the trickling filter process, the majority of active micro-organisms are attached to a filter media and do not pass out the reactor.

### Recirculation

Recirculation is the pumping of wastewater back through the trickling filter. The primary purpose of recirculation is to dilute strong influent wastes and to bring the filter effluent back in contact with the biological population for further treatment.

The rate of recirculation and recirculation scheme may affect removal efficiencies at trickling filter facilities. Studies have shown that no general statement can be made as to the impact recirculation has on BOD removal. This should not be taken to mean that recalculation is of no value

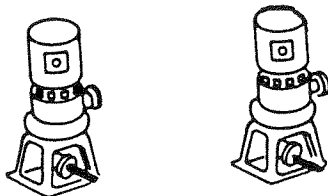

at a trickling filter plant. It is the responsibility of operators to evaluate the effect recirculation has upon effluent quality at their facility.

This must be evaluated carefully because recirculation has other effects upon the facility such as:

### **Why Recirculate?**

- 1) maintaining good distribution of wastewater upon the filter media;
- 2) preventing stoppage of distributor during low flows;
- 3) promoting continuous and more effective sloughing by increasing hydraulic loading;
- 4) reducing strength of wastewater applied to filter;
- 5) reducing thickness of biological film on media by reducing concentration of wastewater applied to filter, thereby preventing ponding;
- 6) reducing fly problems because of more uniform application of wastewater, thereby keeping all areas of media wet;
- 7) reducing odors by increasing dissolved oxygen in the wastewater;
- 8) seeding the applied wastewater with active organisms;
- 9) more effectively using the lower regions of media;
- 10) reducing detention times in clarifiers at facilities hydraulically underloaded if the recirculated wastewater goes through the clarifier; and
- 11) reducing freezing problems.

As a general rule of thumb, recirculation should not be increased beyond a point which would cause the underdrains to be more than half-full. Underdrains flowing more than half-full cause ventilation problems.



### Temperature

Cold weather not only causes problems with freezing in trickling filters, but also reduces the efficiency of the process. Temperature plays an important role because it effects the rate of biological activity in trickling filters. As temperature decreases, biological activity also decreases which results in a poorer effluent quality. The reduction of heat loss through a facility is, therefore, important to maximize removal efficiencies.

To minimize temperature loss, an operator should:

- 1) evaluate the need for recirculation to determine if the rate can be lowered during cold weather operation. Each time wastewater passes through a filter, its temperature is lowered. Care should be taken to be sure that rotation of the distributor is maintained during low flows to prevent any freezing problems. It may be possible to stop recirculation during high daytime flows and again during low-flow conditions which occur during evening and nighttime hours.
- 2) a wind screen, canopy or cover will reduce the cooling effect of wind. Covering a trickling filter also helps to hold heat in the filter and maintain warmer wastewater temperatures.

### Ventilation

A trickling filter is a biological treatment process requiring sufficient ventilation to provide oxygen for aerobic bacteria. If inadequate ventilation is a problem, an operator should find the cause of the problem and correct it. Poor ventilation may be due to:

**Cause of Poor  
Ventilation**

- 1) insufficient temperature differential between the wastewater and surrounding air temperature; however, if the temperature difference is 3°F or greater, there should be sufficient natural ventilation;
- 2) ice build-up on the media surface;
- 3) heavy biological growth on the media;
- 4) broken underdrains;
- 5) debris on the surface of the media;
- 6) plugged media; and
- 7) ponding.

Loading

**Hydraulic Underload**

A trickling filter facility may have problems if the flow received at the facility is much below the design flow. Some of the problems which may develop are:

**Low Flow Problems**

- 1) too long a detention period in the primary clarifiers;
- 2) poor distribution or stoppage of filter arm rotation during periods of low flows;
- 3) inadequate sloughing of biological growth, creating ponding problems;
- 4) low flows may cause dry areas on the filter or walls which result in an excess number of filter flies;
- 5) odor problems due to long detention times in collection systems or clarifiers; and
- 6) freezing problems.

The following operational changes may counteract the effects of hydraulic underloading

**Helpful Hints for Low  
Flow Problems**

- 1) If a facility is hydraulically underloaded and the filters are operated in parallel, the hydraulic loading to the filters can be increased by operating them in series. Series operation also provides a higher quality effluent than does parallel operation.
- 2) Recirculation can be used to increase the hydraulic load to the filters to help maintain rotation of the arms. Recirculation will also help shorten the detention times in clarifiers which are hydraulically underloaded, provided the recirculated wastewater is routed through the clarifiers.
- 3) If a facility has units operating in parallel, it may be possible to remove some of them from operation to increase the flow to the remaining units.

**Hydraulic Overload**

If a trickling filter is hydraulically overloaded, an operator should first determine the cause of it. The overloading problem should be eliminated, but if this is not possible, the following suggestions may help an operator achieve the best quality effluent possible.

**Helpful Hints for High  
Flow Problems**

- 1) An operator should first check the speed or rotation of the trickling filter distributor to be sure it does not exceed the manufacturer's specifications. If the hydraulic load has the filter distributor rotating faster than allowable, an operator should install "hydraulic brakes" on the arms. These are either nozzles or orifices installed on the side of the arms opposite the regular nozzles.

- 2) If the facility has two filters being operated in series, the possibility of operating them in parallel should be investigated. This is not recommended in all cases since the effluent quality may be better with the filters in series. An operator should operate the system so that the best quality effluent is produced.
- 3) Reduction of the recirculation rate will help provide a lower application rate to the trickling filter.

### **Organic Overload**

If a facility receives wastewater with BOD values above those it was designed for, the source of the overloading should be determined and eliminated if possible. It may be necessary for the municipality to require industrial dischargers to pretreat their wastewater before discharging to the municipal system if their discharge causes problems at the facility.

Trickling filters are very rugged biological processes and are not very upset because of organic loads. However, the trickling filter process does not have a lot of operational adjustments which can be used to achieve additional removal efficiencies. One technique which operators can use is to vary the recirculation rate to achieve optimum performance from their facility.

### **Helpful Hints for Organic Overload Problems**

Increasing the recirculation rate may prove beneficial by:

- 1) reducing the concentration of wastewater being applied to the filter through dilution;
- 2) providing additional hydraulic load to the filter which will increase sloughing and prevent possible build-up of organic material and pending problems; and by

- 3) more effectively using the lower regions of the media.

### Filter Flies (psychoda)

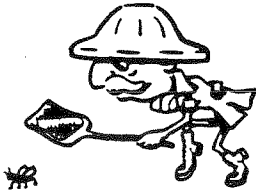

The filter fly is a small gnat-sized fly, whose larvae live in the biological slime on the filter media. The filter fly prefers an alternate wet and dry environment and, therefore, is more frequently a problem in low-rate filters than in high-rate filters.

Filter fly larvae are one of the natural biological organisms found in the slime on the media which actually assist in decomposition of organic matter. If the larvae hatch into flies and the number of filter flies become excessive, they may have to be controlled by various methods.

The main method of controlling filter fly population is by keeping the walls and media constantly wet so the larvae cannot move into a dry area and hatch into flies. Other methods include increased recirculation, nozzle adjustment on the distributor arms, flooding the filter and chlorination.

## MAINTENANCE

### Distribution

Even distribution of wastewater over the media is necessary to provide proper maintenance of a distribution system. If proper maintenance is not provided, it can cause a trickling filter to be inefficient.

Listed below are items to be aware of in the maintenance of a distribution system.

- 1) To provide good distribution, remove daily any obstructions in the nozzles and/or orifices. If





necessary, mechanical adjustment of the nozzles should be made at this time.

- 2) Daily observations and records of changes in a distribution system should be made for future reference, along with any maintenance work performed. Watch for excessive leakage from the seal which would indicate problems with it.
- 3) The oil level should be checked in the bearings at least once a week.
- 4) Oil should be changed at intervals specified by the manufacturer, or sooner if contaminated.
- 5) Vary the recirculation rate to provide maximum efficiency, but be careful to maintain rotation at all times if possible.
- 6) Check the level of arms and adjust them seasonally if necessary.
- 7) Always look for indications of bearing failure. Stoppage of rotation during low flows and refusal of the arms to begin rotation may indicate problems with the bearings. If a facility experiences a flow sufficient to maintain continuous rotation, the first indication of bearing failure may be a popping or grinding noise coming from the bearings.

## Media

Maintenance procedures for the media of a trickling filter are limited. An operator should keep in mind that the basic function of the media is to provide a surface for biological growth and to provide void spaces for ventilation. An operator should strive to ensure that these requirements are being met at all times. The following suggestions will serve as a guide upon which operators can base their operation and maintenance work relating to the media.

- 1) Daily remove debris which may have accumulated on the surface of the media, e.g., in the fall of the year, leaves may present problems.
- 2) Daily visual observations of the trickling filter should be made and recorded. A change in color of the biological growth on the media may be an indication that toxic industrial wastes are being applied to it.
- 3) Watch primary effluent conditions to be sure that grease or toxic industrial wastes are not being applied to the media.
- 4) Check the media for indications of ponding. It should be emphasized that not all ponding is as obvious as standing water on the surface. An operator should remove some of the media rock to see if ponding may be just below the surface.
- 5) Remove any build-up of ice which may accumulate.
- 6) Odor problems may be an indication of organic overload, excess organic growth, septic discharge or poor ventilation, etc.

## **Ponding**

- 7) Check to be sure that all areas of the media are receiving a good distribution of wastewater.
- 8) Do not needlessly flush the biological slime from the media. Some operators have been told to clean the media periodically with high-pressure hoses. Unless the growth is excessive, there is no need to flush the media. In fact, this may do more harm than good.
- 9) Do not use heavy equipment in the filter because the weight of such units may damage the media or underdrains.

Backflushing for approximately 24 hours may help remove excessive biological growth. Other methods should be attempted first because removing a filter from operation may result in poor effluent quality. If a build-up of biological growth is due to high organic loading and low hydraulic loading, a higher recirculation rate may help keep the growth from becoming excessive.

#### Underdrain

Maintenance procedures for the underdrain system in a trickling filter are also limited. An operator should keep in mind that the basic functions of the underdrain system are to support the media, to allow flow of oxygen through the media, and to collect the wastewater. An operator should see that these requirements are met at all times.

The underdrains should be inspected daily for signs of disintegration or blockages. Broken tile or rock should be removed to prevent this material from washing through to the following treatment units.

### **Functions**

### **Inspect Daily**

If there is an accumulation of slime growth in the underdrain system, it should be removed to prevent odor problems. If provisions are made for flushing underdrains, it should be done frequently with a high-pressure hose to prevent an accumulation of solids which reduce ventilation.

Underdrain channels can be dangerous because of slippery conditions due to biological growth. Because of this, be sure the area has proper lighting.

### Efficiency of Other Treatment Units

Problems with other treatment units may affect removal efficiencies in a trickling filter. Proper operation and maintenance of preliminary and primary treatment units and digesters is essential to achieve maximum removal efficiencies in a trickling filter.

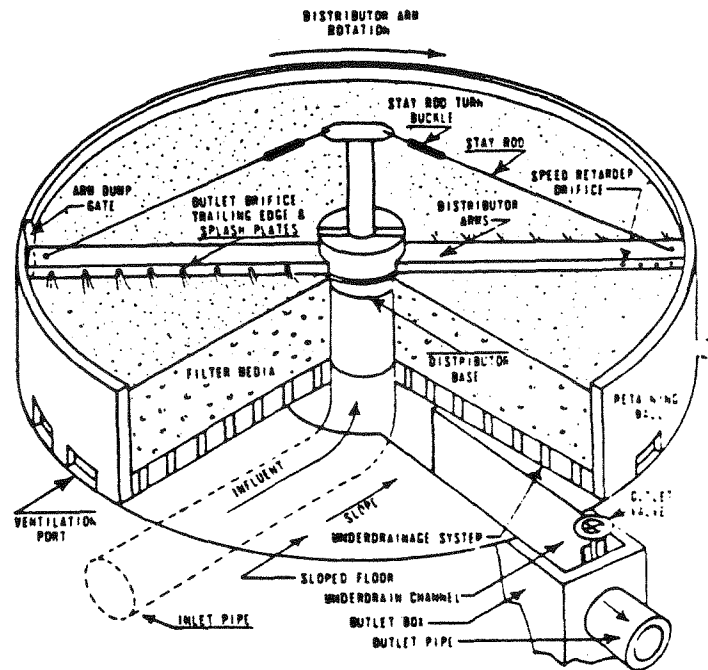

The best designed plant, constructed to exact specifications, can still produce poor-quality effluent if operated improperly.

## REFERENCES

1. Operation and Maintenance of Wastewater Treatment Plants, California State University, Sacramento.
2. Trickling Filter Manual, Minnesota Pollution Control Agency.
3. Sewage Treatment Plants and Sewer Systems at Fixed Installation 1145, Technical Manual TM5-666, U.S. Army.
4. Operation of Wastewater Treatment Plants, Manual of Practice No. 11, Water Pollution Control Federation.
5. A Literature Search and Critical Analysis of Biological Trickling Filter Studies, U.S. Environmental Protection Agency.
6. Wastewater Plant Operators Manual, State of Washington.

# ROTATING BIOLOGICAL CONTACTORS

## TABLE OF CONTENTS

	<u>PAGES</u>
<u>INTRODUCTION</u>	92
<u>THEORY</u>	92
<u>DESIGN</u>	93
Tankage	
Media	
Drive Assembly	
Cover	
Staging	
Loadings	
Design Variations	
Nitrification	
<u>OPERATION</u>	100
Biomass Observations	
Series/Parallel Operation	
Recirculation	
<u>MAINTENANCE</u>	103
<u>REFERENCES</u>	104

# ROTATING BIOLOGICAL CONTACTORS

## **Similar to Trickling Filter Process**

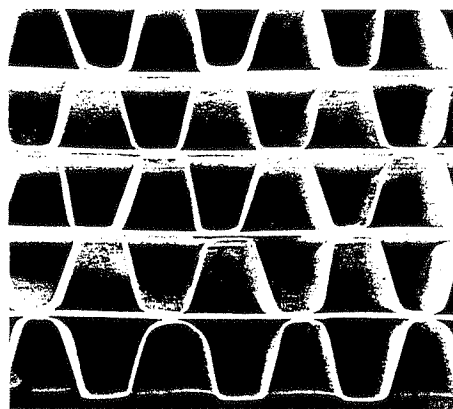

Media cross section

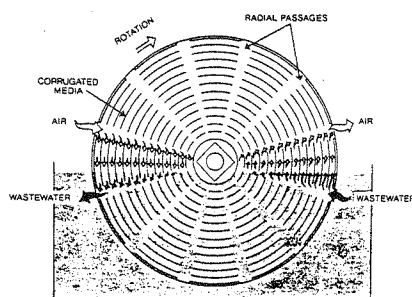

End-view sketch illustrates exchange of air and wastewater

## **Oxygen is Transferred from the Atmosphere**

## INTRODUCTION

The rotating biological contactor (RBC) process is a fixed film process, similar to the trickling filter process. An RBC may be thought of as a trickling filter tipped on its side. Instead of the wastewater trickling through the media, the media rotates through the wastewater. The process provides secondary treatment and is used worldwide for both municipal and industrial wastewater treatment. The first RBC system was installed in West Germany in 1960. There are 24 operating systems in Minnesota in 1995.

## THEORY

The most common RBCs have a rotating shaft surrounded by plastic discs called the media. The shaft and media are called the RBC unit. The media rotate in a tank of wastewater. Approximately 40 percent of the media surface is submerged in the wastewater. As the RBC unit rotates, the media picks up a thin layer of wastewater which flows over it. A biological slime growth or biomass grows on the media.

Much of the biomass consists of aerobic micro-organisms that break down organic matter in the presence of dissolved oxygen. The organic material present in the wastewater provides food for the micro-organisms. Oxygen is transferred directly from the atmosphere into the biomass as the RBC unit rotates.

**Sloughed Material Flows  
Into a Secondary  
Clarifier**

As the biomass thickens, the organisms nearest the media are not able to adsorb an adequate amount of organic matter and they begin to die. These organisms slough off the media and a new slime layer begins to grow. The sloughed material flows into a secondary clarifier where settling occurs. Sloughing reduces the biomass weight on the RBC unit. The sloughing rate is impacted by several things, including hydraulic loading, temperature changes, environmental conditions, etc. Biological growth and sloughing occur continuously in the RBC process. The RBC process removes 80 to 95 percent of the soluble BOD.

DESIGN

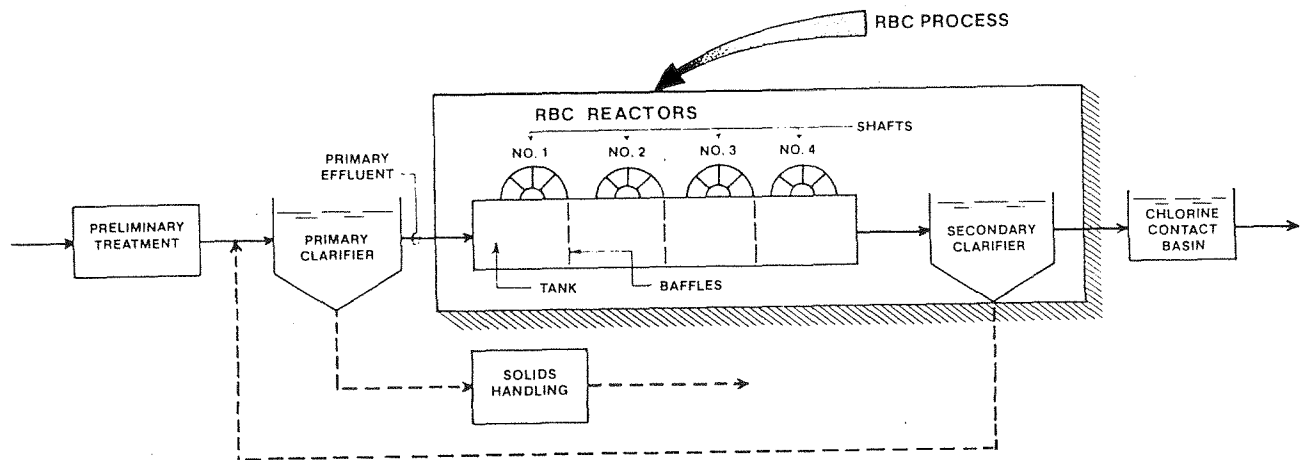

- Components:**
- Tank**
  - Media**
  - Drive Assembly**
  - Cover**

The RBC process is dependent upon good preliminary and primary treatment processes to reduce the solids or BOD of high-strength influent loadings that could otherwise result in interference or overload. Preliminary treatment including grit and rag removal and primary treatment including either primary clarifiers or screens are necessary to remove



materials that may settle in the RBC tankage or plug the media. Some RBC systems have aerated flow equalization basins instead of primary clarifiers before the RBC units. Raw wastewater should never be applied directly to an RBC system.

An RBC system generally includes four components: 1) tankage; 2) media; 3) drive assembly; and 4) cover.

### Tankage

Tankage for RBC equipment may consist of metal tanks or concrete basins. The volume of the tank is designed to provide approximately one hour of detention time. Metal tanks may be used for small pilot plants or single-shaft units. Multi-shaft units are typically housed in concrete tanks separated by baffles or weirs used to control the wastewater flow. The baffling used to separate multi-shaft units may consist of either concrete or wood. Removable baffles are often used to allow for system process changes. These baffles are a very important operational feature in the RBC system.

### Media

The media used in RBCs usually consists of circular plastic. There are two broad categories of plastic RBC media: low-density media with wider spacing, and high-density media with closer spacing of the individual discs. Low-density media contains about 100,000 square feet of surface area per shaft. High-density media are generally used in the later or nitrification stages of RBCs and contain approximately 150,000 square feet of surface area per shaft.

**Media Consists of Circular  
Plastic Disks**

**Low Density Media  
vs.  
High Density Media**

**Media is Typically 12 Feet  
in Diameter**

Low-density media contain more void space to treat greater amounts of BOD. High-density media contain less void space to treat lesser amounts of BOD.

The media discs have a maximum diameter of 12 feet, set by maximum allowable road vehicle height. The discs are mounted on long, horizontal rotating steel shafts. The shafts are covered with a heavy protective coating suitable for use in water and high humidity conditions. The maximum shaft length is 27 feet. The discs are spaced on the shaft according to various configurations. The number of discs per shaft and the disc diameter determine the media surface area available for biomass growth. The empty weight of an RBC unit is approximately 25,000 pounds. An RBC unit with low-density media that has a full biomass growth weighs between 40,000 and 70,000 pounds.

The media in an RBC system require little maintenance. However, it is possible for media failure to occur due to extended exposure to heat, concentrated organic solvents, or ultraviolet radiation. Media may also fail because of stress cracking. Stress cracking is an internal or external rupture in the plastic caused by stresses on the media. Shaft breakage may also cause media separation. In addition, media may separate without shaft breakage.

Drive Assembly

**Drive Assembly:**  
**Motor**  
**Air Drive**  
**Dual (air with**  
**mechanical assistance)**

Three types of drive assemblies are used to rotate the shafts supporting the media: 1) motor, 2) air drive, and 3) dual drive (air drive with mechanical assistance). With any of the drive assemblies, the main shaft is supported by two main bearings. At least one of the bearing is designed to

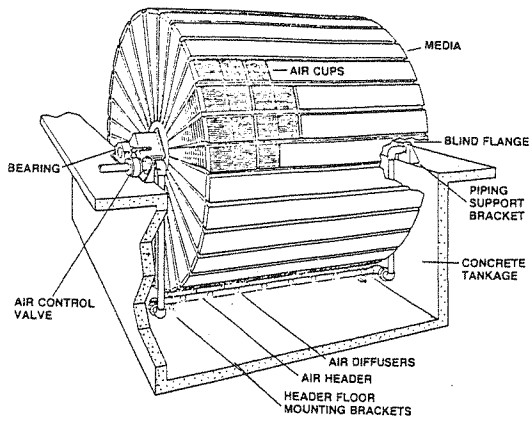

**MEDIA**  
Media with polyethylene air cups attached to the outer perimeter capture air as it is released from the air header.

**AIR CUPS**  
Air cups, attached to the media, capture air which in turn rotates the media.

**AIR CONTROL VALVE**  
Butterfly control valve controls inlet air supply to each unit.

**AIR HEADER**  
Lightweight headers that carry the air through the system run the length of the media assembly and are easily removable for cleaning.

**HEADER FLOOR MOUNTING BRACKETS**  
Brackets secure header to the floor of the tank.

**AIR DIFFUSER**  
Coarse-bubble air diffusers distribute air from the header into the air cups and media.

**PIPING SUPPORT BRACKET**  
Bracket on each end of the header holds unit in place.

accommodate thermal expansion as the shaft heats and cools. Most shafts have one expansion and one nonexpansion bearing.

Motor drive assemblies can either use a chain and sprocket assembly to rotate the shaft or have direct shaft drive. The motors are typically rated at 5.0-7.5 horsepower and may be equipped to allow installation of an electronic speed controller to vary rotational speed. However, most mechanical drives rotate at a constant speed. Motor-driven shafts are generally rotated at a speed of 1.6 revolutions per minute (rpm).

### Motor-Driven Shafts Rotate at 1.6 RPMs

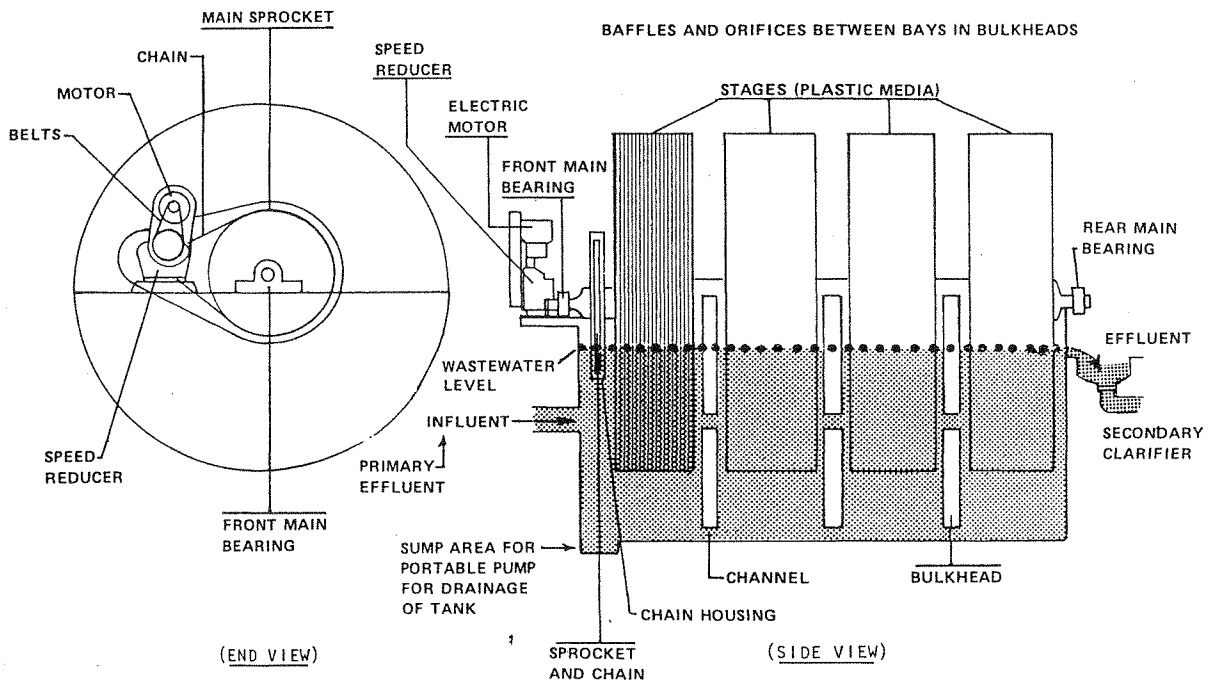

**Air-Driven Shafts Operate  
at 1-1.4 RPMs**

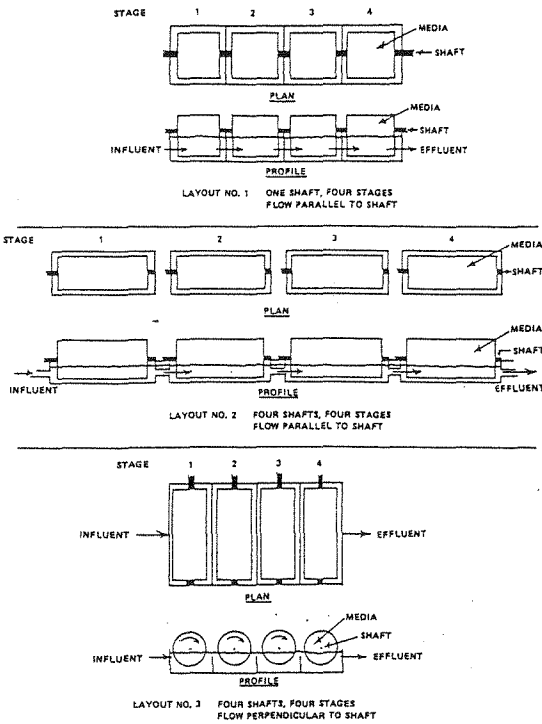

**Baffles Separate Stages**

**Staging Increases  
Effectiveness of Media  
Surface Area**

Air drive assemblies consist of plastic cups attached to the media. The cups are four or six inches deep, depending on location, to accommodate and collect the air flow. The assemblies have an air diffuser at the bottom of each RBC shaft. The air cups trap air bubbles released from the diffuser. As the bubbles rise, they cause rotation of the RBC shaft. Air-driven shafts operate at rotational speeds of 1.0 to 1.4 rpm. The rotational speeds can be varied by adjusting the air flow to each shaft.

**Cover**

The cover for an RBC unit frequently consists of fiberglass or other reinforced resin plastics. It is also possible to place a number of shafts within a building or have a combination of covers and buildings. The cover or enclosure is provided to protect the biomass from the weather, ultraviolet radiation and to contain odors. Any RBC enclosure must have ventilation, humidity and condensation control, and heat loss provisions.

**Staging**

The RBC process is usually divided into different zones or stages. Each stage is separated by a removable baffle, concrete wall, or cross-tank bulkhead. Each baffle has an underwater opening to permit flow from one stage to the next.

Staging is used in order to increase the effectiveness of a given amount of media surface area. A single shaft can be divided into two or more stages by adding baffles between

sections along the flow pattern and having different densities of media. Micro-organisms on the first-stage media are exposed to high BOD concentrations and reduce it at a rapid rate. As the BOD concentrations decrease from stage to stage, the rate at which the biomass can remove BOD decreases and nitrification begins.

A stage may also be eliminated by removing a baffle. The use of several parallel series of stages (sometimes referred to as a train) reduces loadings on the first or initial RBC stages. Flexibility in the system through the use of a number of gates and baffles allows the operator to vary the flow pattern to accommodate specific load and effluent quality criteria.

#### Loadings

**Allowable Organic Loading  
is from 2.5 to 4.0 Pounds  
of Soluble BOD Per Day  
Per 1,000 Square Feet**

Loadings for RBCs are usually based on BOD loading to the RBC units. It is expressed as pounds of soluble BOD applied per day divided by the surface area of the media (in 1,000 square feet). Organic loading is usually calculated for all (total) units on line or sometimes simply for the first stages. The organic load should be in the range of 2.5 to 4.0 pounds of soluble BOD per day per 1,000 square feet. Electronic or hydraulic load cells can be used to periodically measure total shaft weight. Some shafts have a load cell device installed under the shaft support bearing on the idle end of the shaft. Such a cell has a hand-operated hydraulic pump to lift the bearing from its base and generate hydraulic pressure that can be converted to shaft weight. Load cell information is used to judge the condition of biomass growth

and weight. The hydraulic loading rate for a system designed for organic removal is approximately two to four gallons of primary treated wastewater per square foot of media per day.

Since a higher percentage of carbonaceous material is removed initially, the first and second stages of the RBC process will have the thickest biomass and heaviest shaft loads. If shaft design loads are exceeded, sloughing may be increased by speeding up or reversing the rotation, adding chemicals or additional air, increasing recirculation or isolating the affected area or shaft. The RBC unit should never be drained with a full load of biomass; it may break the shaft.

Excessive loading in the first stages of an RBC system can cause oxygen depletion problems. A train is commonly used to reduce loadings on the first RBC stages. If the first stages are not overloaded, addition of trains or stages can be used to increase system performance.

#### Design Variations

#### **Submerged Biological Reactors are 90 Percent Submerged**

The submerged biological reactor (SBR) is similar to the RBC. The SBR differs from the RBC in that it is 90% submerged in the wastewater and can be up to 19 feet in length. Oxygen is added to the tank through a blower.

#### Nitrification

An RBC system can also be used for nitrogen removal or nitrification. As the BOD removal rate decreases, the number of nitrifying bacteria will increase to a point where efficient removal is possible. The transition occurs at a BOD

concentration of approximately 15 milligrams per liter. The loading rates for nitrogen removal are significantly different. Nitrogen removal occurs in the later stages of the RBC process. The hydraulic loading rate for a system designed for nitrogen removal is one gallon per square foot of media per day (the loading rate for a system designed for organic removal is two to four gallons per square foot of media per day).

Nitrification is very sensitive to dissolved oxygen and pH values. A minimum dissolved oxygen concentration of 2.0 milligrams per liter and pH values ranging from 7.0 to 9.0 is needed for nitrification to occur. Decreasing wastewater temperatures can also decrease the growth rate of nitrifying organisms.

### OPERATION

When properly designed and loaded, RBCs can provide trouble-free secondary treatment. When problems occur, it is important to have good records and data from the RBC process. Records of total and soluble BOD, suspended solids, organic and ammonia nitrogen, pH, alkalinity, DO, and other parameters are necessary to recognize trends that may have an adverse impact on the system. Troubleshooting operational problems can be made easier if past experience with the RBC system is documented.

### Biomass Observations

#### **Operator Needs to Observe Condition and Color of Biomass**

The most important part of process control for an RBC is daily inspection of the RBC units. The operator should look at the condition of the biomass in each stage and test the

dissolved oxygen exiting each stage. The color of the biomass can be used to determine how the system is functioning. A healthy first-stage biomass is uniformly greyish brown and distributed in a thin, even layer.

**White or Black May  
Indicate Overloading**

If the biomass is white or black, the system may be overloaded. The white color may be due to bacteria which feed on sulfur compounds. The overloading could result from industrial discharges, inadequate preliminary treatment, inadequate baffling, etc. Pre-aeration of the influent may resolve the problem. If the system is severely overloaded, the baffle between stages one and two should be removed. This helps distribute the load between the two stages. Also, prechlorination of the influent may assist in controlling sulfur-dependent bacteria.

**Low DO Concentrations**

A black, odorous biomass may also indicate that the system is overloaded. This condition would probably be accompanied by low dissolved oxygen concentrations in the effluent. Again, pre-aeration and/or changing the baffles may solve the problem.

Low dissolved oxygen concentrations may be the result of high organic loading. For CBOD removal, a minimum dissolved oxygen concentration ranging from 0.5 to 1.0 milligrams per liter is needed at the end of the first stage, and at least two to three milligrams per liter is needed at the end of the last stage of the RBC unit. While low or falling dissolved oxygen concentrations from stage to stage may indicate an overloaded system, increasing the concentrations may not overcome performance problems.

**Wastewater Temperature**



## **Proper pH Range**

Temperature and pH also affect system performance. Wastewater temperatures below 55 degrees Fahrenheit will result in a reduction of biological activity. The pH values in the RBC unit should be within a range of 6.0 to 9.0. Low or high pH may require chemical treatment to adjust the pH back to neutral.

An RBC unit can also experience an imbalance which is caused by uneven growth on the media. Uneven growth can cause the shaft to break and/or media to separate. This imbalance problem may be worse in an air drive system.

## Series/Parallel Operation

**Series vs.**

**Parallel Operation**

Larger RBC systems can be run in a series or parallel mode of operation. In the series mode, the wastewater flow is treated by one RBC unit and then flows through a second unit. The two RBCs may or may not be separated by a clarifier. In parallel mode, the flow is divided into two parallel systems after preliminary treatment. The effluent from either mode must flow into a clarifier for settling of suspended solids that have been sloughed off the RBC unit.

## Recirculation

RBC systems do not normally require recirculation. The biomass growth and sloughing is repeated continuously and is usually a once-through process. Although recirculation may not significantly improve treatment efficiency, it may be used in certain conditions, such as when high industrial or organic loads occur, to avoid overloading the system.

## MAINTENANCE

Maintenance of an RBC system focuses on the media and the drive system. Unlike trickling filters, ponding and filter flies are not problems. Proper operation of the system is dependent upon daily inspections and maintenance.

It is possible for snails or moss to grow in the RBC unit. Both may cause operational problems. One possible cause may be reduced organic loadings to the unit.

Removing baffles may resolve this problem by increasing the load to the latter stages of the RBC unit. If the snails or moss do not disappear after baffles have been removed, it may be necessary to chemically treat them.

An additional cause of moss growth may be overexposure to sunlight. Covering the RBC unit with a dark or solid-colored cover will reduce the amount of sunlight.

One serious problem than can occur in an RBC system is a broken shaft. Broken shafts are very labor intensive and difficult to repair. The shaft must be raised and the media removed in order to install a new shaft. The breakage may cause damage to the media or cause the media to shift. The biomass weight should be carefully monitored in order to avoid this problem.

### **Daily Inspection of Chain Drives, Belt Drives, Sprockets**

Daily inspection of the chain drives, belt drives, sprockets, and other moving parts should be made. All exposed parts should be painted and/or covered with a layer of grease to prevent rust. Motors and other metal parts should be painted for protection. Shaft bearings also require periodic maintenance. Greasing is important to prevent corrosion.

Proper maintenance of the RBC will support good treatment system performance. However, problems with other treatment units will interfere with the efficiency of the RBC process. It is important that the whole system be properly operated and maintained. When all treatment units are operated and maintained correctly, the RBC system will be able to achieve maximum removal efficiencies.

## REFERENCES

1. Operation and Maintenance of Wastewater Treatment Plants, California State University, Sacramento, California.
2. Upgrading of Rotating Biological Contactor (RBC) Systems to Achieve Higher Effluent Quality, Including Biological Nutrient Enrichment and Reduction Techniques, Kenneth E. Nev, Environmental/Health Services.
3. MOP-11-Operation of Wastewater Treatment Plants, Vol. II, Water Environment Federation.
4. Designing Information on Rotating Biological Contactors, U.S. Environmental Protection Agency.
5. Aero-Surf Air Drive System, Autotrol Corporation.
6. Summary of Design Information on Rotating Biological Contactors, U.S. Environmental Protection Agency.
7. Rotating Biological Contactors (RBCs), Checklist for A Trouble-Free Facility, U.S. Environmental Protection Agency.
8. RBC Information Update, U.S. Environmental Protection Agency, Region 5.
9. Why Not Use a Rotating Disk?, H.E. Knowlton, Chevron Research Co., Richmond, California.

# ACTIVATED SLUDGE

## TABLE OF CONTENTS

	<u>PAGES</u>
<u>INTRODUCTION</u>	106
<u>THEORY</u>	106
<u>DESIGN</u>	110
Conventional	
Contact Stabilization	
Extended Aeration	
Oxidation Ditch	
<u>OPERATION</u>	113
Control	
Observations	
Control Tests	
<u>MAINTENANCE</u>	126
<u>REFERENCES</u>	130

## INTRODUCTION

Wastewater which enters a treatment facility contains large amounts of organic matter. This organic matter, if not properly removed, will enter the receiving stream causing potentially obnoxious conditions and adversely affecting the receiving waters. The purpose of a treatment facility is to remove enough of the incoming organic matter so that the treated wastewater can be safely discharged to a receiving stream.

Organic matter enters a treatment facility either as a settleable solid which will easily settle out or as a colloidal solid or dissolved solid which will not easily settle out. The major purpose of an activated sludge system is to convert the non-settleable solids (colloidal and dissolved) to a solid which will settle and can easily be removed by a clarifier. The biological activity in a properly operated aeration tank accomplishes this conversion so that organic matter can be removed in the final clarifier.

## THEORY

The activated sludge process, like most other types of secondary treatment, is an aerobic biological treatment process, biological meaning that bacteria and other micro-organisms are essential to a treatment process, aerobic meaning that these micro-organisms need air or dissolved oxygen to breathe. These micro-organisms are typical of all living things in that they need food, oxygen and a home or healthy environment to live and reproduce.

**ACTIVATED SLUDGE:**  
**Sludge consisting of**  
**aerobic bacteria and**  
**other organisms**

**Home**  
**Food**  
**Oxygen**  
**Micro-organisms**

The home in an activated sludge system consists of an aeration tank and a final clarifier.

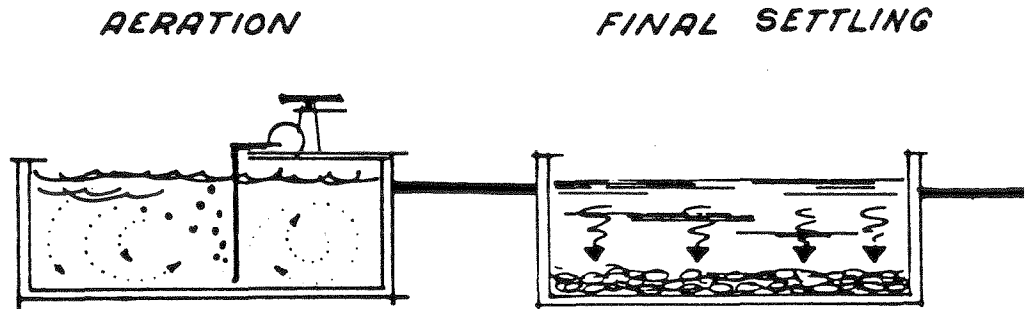

### Diffused Aeration

### Mechanical Aeration

### MIXED LIQUOR: Sludge and liquid mixture in the aeration tank

The food and water needed by micro-organisms are supplied by the wastewater (the food being the organic solids found in the wastewater). As wastewater enters the aeration tank, it is mixed with micro-organisms by either diffused or mechanical aeration. This aeration provides micro-organisms with the oxygen they need. It also brings them into contact with the food. This mixture of wastewater and micro-organisms in the aeration tank is called mixed liquor.

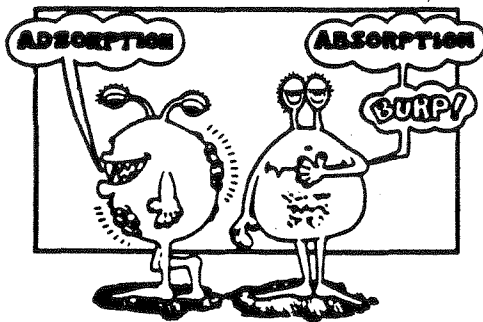

As the food comes in contact with micro-organisms in the aeration tank, it is broken down by them through the processes of adsorption and absorption. Adsorption refers to the attachment of food to the outer layer of micro-organisms. This usually happens during the first half-hour after the food enters the aeration tank. Absorption refers to food being taken into the body of the micro-organisms. Micro-organisms release chemicals called enzymes which break down adsorbed (attached) food particles so they can be absorbed by micro-organisms.

**Floc: Clumps of  
micro-organisms**

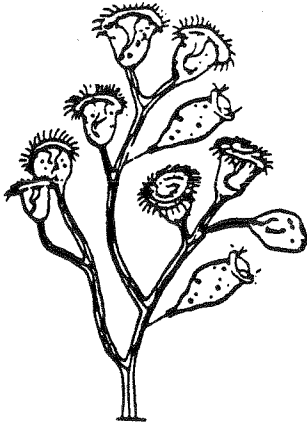

**Settling Tank**

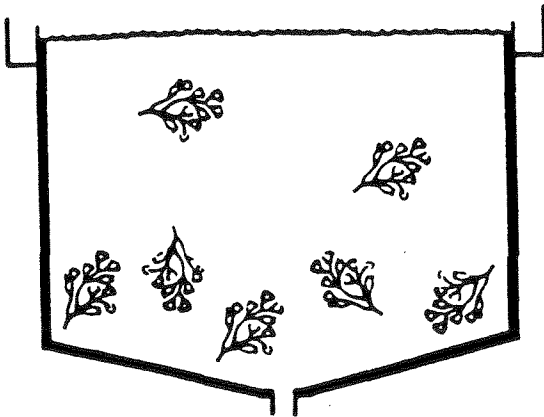

**RETURN SLUDGE:**  
Sludge returned from  
the clarifier to the  
aeration tank.

As micro-organisms are mixed in the aeration tank, they clump together to form a brownish floc called activated sludge. It is this floc which gives the tank contents its brown color.

As influent wastewater flows into the aeration tank, an equal amount must flow out the other end. If this aeration tank discharged directly to a receiving stream, the discharge would not meet effluent limits and all the micro-organisms would be lost from the system. In order to capture these micro-organisms and prevent them from entering a receiving stream, the aeration tank is followed by a clarifier. If the system is operated properly, the floc will have acquired sufficient weight and density in the aeration tank to be able to settle out in the final clarifier. The floc settles and a clear liquid effluent, low in BOD and solids, passes over the weirs. But what happens to micro-organisms which settle out? If they were allowed to accumulate in the clarifier, they would soon fill it up and then overflow to a receiving stream. Therefore, the settled micro-organisms need to be removed from the clarifier. Also, if all the micro-organisms were allowed to accumulate in the clarifier, the aeration tank would lose all its microbial population and be unable to adequately treat wastewater. Returning micro-organisms back to the head of the aeration tank maintains a high micro-organism population in the aeration tank for handling incoming food.

This return of micro-organisms from the final clarifier to the aeration basin is called return sludge or return activated sludge (RAS).

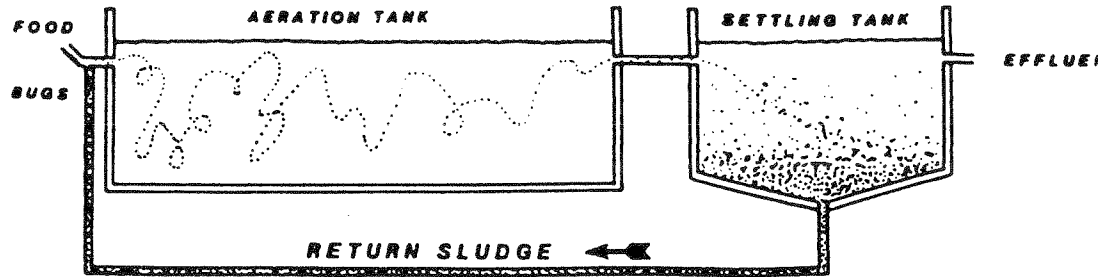

This return sludge flow should be continuous. The return sludge flow rate is generally expressed as a percentage of the influent wastewater flow rate.

**WASTE SLUDGE:**

**Excess sludge removed from the secondary treatment system**

The micro-organisms are continually reproducing in the aeration tank. This results in more micro-organisms being produced than are needed. Therefore, a certain portion of them have to be removed or “wasted” from the system. This is usually done by wasting from the return sludge line because this is the highest concentration of micro-organisms in the system. The micro-organisms are wasted to some type of solids handling system for further treatment and eventual disposal. Once the excess micro-organisms have been removed from the aeration tank/clarifier to the solids handling unit, they should not be allowed to return to the aeration tank.

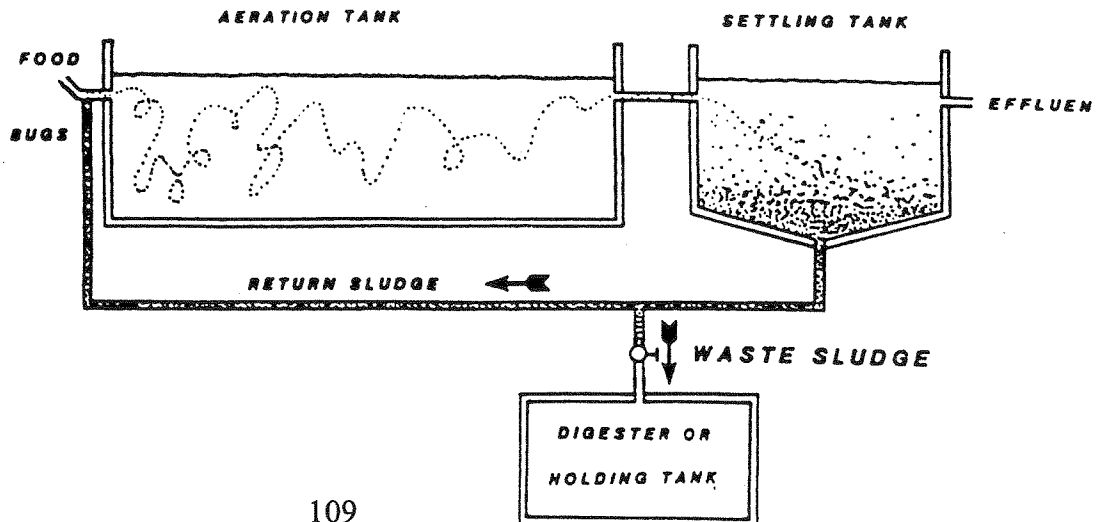



Wasting of micro-organisms is the single most important adjustment which an operator can use to properly operate an activated sludge facility. Wasting of solids regulates the population of micro-organisms in a system, which is the biggest operational factor in whether the facility will meet its effluent limits or not. Wasting should be done daily to maintain consistent conditions in a system.

## DESIGN

There are three general types of activated sludge facilities. These types include conventional, contact stabilization and extended aeration.

### Conventional

In the conventional process, wastewater enters the aeration tank at one end. The mixed liquor formed is detained in the aeration tank from four to eight hours. During the time which mixed liquor is in the aeration tank, micro-organisms break down organic pollutants by adsorption and absorption. The micro-organisms (as activated sludge) are continuously flowing to the clarifier where they are allowed to settle to the bottom. The settled activated sludge is continuously returned to the head of the aeration tank or a portion is wasted to the digester.

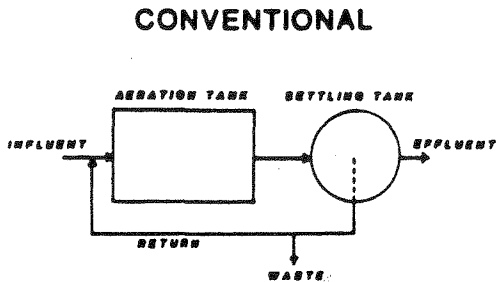

The parameters which distinguish conventional activated sludges from the other types are the four to eight-hour detention times and 1,500-3,000 mg/l concentration of solids in the aeration tank and a return rate of 25-75 percent of the influent flow rate.

## CONTACT STABILIZATION

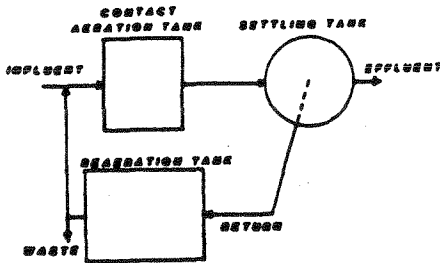

### Contact Stabilization

The contact stabilization process is different from the above-mentioned process in that it provides two aeration tanks for micro-organisms to break down organic pollutants. The first aeration tank is called a contact tank. In this tank, the organic particles are adsorbed by the micro-organisms in a short time. Detention time in this tank ranges from one-half to one hour. The mixed liquor flows from the contact tank to the clarifier where sufficient time is provided to allow the solids to settle. As this sludge settles, it leaves a clear liquid, low in BOD and suspended solids, which flows over the weirs as effluent. The settled activated sludge is continuously transferred to the second or reaeration tank for further processing.

It is in the reaeration tank that the micro-organisms are given enough time, four to eight hours, to absorb the food. During this time, new cell life (micro-organisms ) is produced and organic pollutants are established.

Micro-organisms are returned from the reaeration tank to the contact tank to ensure an adequate amount of them for the incoming food. Excess sludge is usually wasted to the solids handling unit from the reaeration tank.

Design parameters for contact stabilization include one-half to one hour detention time in the contact tank, four to eight hours in the reaeration tank, 1,000-3,000 mg/l solids in the contact tank and a return sludge rate from the clarifier of 25-100 percent of the influent flow rate.

## EXTENDED AERATION

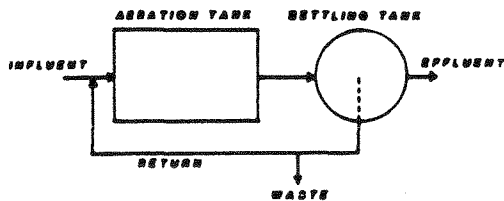

### Extended Aeration

The extended aeration process is another modification of activated sludge. Extended aeration is somewhat similar to the conventional activated sludge process except it uses a higher mixed liquor concentration (more micro-organisms) and has a detention time which ranges from 16 to 24 hours in the aeration tank.

Because of the large number of micro-organisms in the aeration tank and the longer detention time, there is usually not enough food to go around. This causes the micro-organisms to use their own stored food to a larger extent than the other processes. Also, more micro-organisms die from starvation and their stored food is used by other living micro-organisms.

Although extended aeration does not produce as much sludge as the other processes, it still must be controlled by proper wasting. Otherwise solids will be discharged from the clarifier, making a good quality effluent impossible to attain.

The important design parameters peculiar to extended aeration are the long detention time in the aeration tank (16-24 hours), a higher concentration of micro-organisms (2,000-6,000 mg/l) and a higher return sludge rate (75-200 percent).

## OXIDATION DITCH

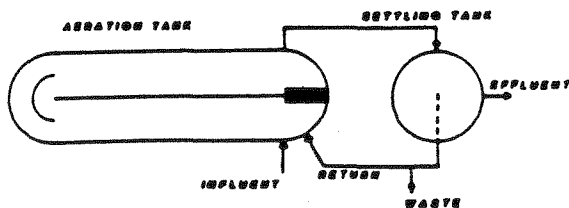

### Oxidation Ditch

A different form of extended aeration is the oxidation ditch. The oxidation ditch is an extended aeration facility which consists of a long, circular, oval or horseshoe shaped ditch. The process uses aerators to provide oxygen and to

mix the mixed liquor by moving the contents around the ditch.

The mixed liquor moves at a velocity which keeps the solids in suspension as they travel around the ditch. Other than its unique shape and method of aeration, the oxidation ditch operates as an extended aeration unit using similar design parameters, detention times and operational procedures.

### OPERATION

With proper operation, a well-designed activated sludge facility can consistently produce a clear and stable effluent. Proper operation involves maintaining a correct micro-organism population, adequate aeration and a favorable environment for the micro-organisms.

There are three main controls available to an operator which greatly influence the quality of effluent produced. These are aeration, return sludge and wasting rates.

#### **AERATION RATE**



**1-2 mg/l dissolved oxygen**

The aeration rate is adjusted by an operator to maintain proper dissolved oxygen levels in the aeration tank. The dissolved oxygen concentration should be one to two milligrams per liter (mg/l). The dissolved oxygen concentration is controlled by the amount of air added to the aeration tank by the aerators.

#### **RETURN SLUDGE RATE**

The return sludge flow rate assures that a large population of micro-organisms is available in the aeration tank at all times. The return sludge rate is normally continuous and constant, but can be increased or decreased with changes in flow or organic loading.

## WASTE SLUDGE RATE

The wasting rate is used by an operator to control the amount of micro-organisms in the aeration tank. The key to producing a good effluent is to maintain the right amount of micro-organisms in the system. Without this proper balance between the amount of food and the amount of micro-organisms, a good settling floc will not develop.

## YOUNG SLUDGE

If too few micro-organisms are maintained in the system, there will not be enough to handle the incoming food. Young sludge is a term which means not enough micro-organisms. If too many micro-organisms are kept in the system, they will not have enough food and will starve.

## OLD SLUDGE

This condition is called old sludge. Under either of these conditions, a good floc will not be formed and it will not settle well in the final clarifier. The amount of micro-organisms in the aeration tank is directly controlled by wasting sludge from the system. Wasting should be done frequently and in small amounts; wasting continuously or at least several times a day being ideal.

## WASTE SLUDGE:

**Waste frequently and  
in small amounts**

Control tests described in the next section can be used to determine if the proper balance exists.

### Control

If observations or control test results show an unfavorable dissolved oxygen or micro-organism concentration, the effluent will probably be poor. The operator then must make changes in the aeration rate, return rate, or wasting rate to correct the situation. However, any changes made should be small. Large changes in the aeration, return or wasting rates should be avoided. After any change is made, observations and test results should be

watched closely for at least one week before making any further adjustments to ensure that the correct change was made.

**Observation and Control  
Tests: communication  
between the micro-  
organisms and an  
operator**

How do we know how much air and how many micro-organisms to keep in the system? The micro-organisms tell us. They will give certain indications that a problem exists and what the problem is. These indications can be interpreted by observing the treatment facility and running control tests. These observations and control tests are the only means of communication between the micro-organisms and an operator. The following describes how to use observations and control tests to control the aeration, return sludge, and wasting rates for efficient plant operation.

Observations

**OBSERVATIONS**

The wastewater from different treatment facility units may not always look or smell the same. Certain odors, colors, and other wastewater characteristics which can be observed by an operator can indicate either good or poor operation. The routine daily inspection of the plant to make these observations should never be omitted.

**Earthy Odor**

Odor at the treatment facility may be used to indicate good or poor operation. An earthy, but not unpleasant, odor indicates that conditions are good. A hydrogen sulfide (rotten egg) odor, however, indicates problems. This unpleasant odor may be coming from the influent wastewater or any of the treatment units. In any case, a problem exists which must be investigated. This odor from an aeration tank usually means a low dissolved oxygen concentration and the aeration rate should be increased.

### **Dirty Dishwater Color In Influent**

The color of the influent wastewater is useful in evaluating what is being discharged to the plant by various industries. Some industrial wastewater contains certain recognizable colors. For instance, dairy industries sometimes discharge milk by-products which turn the wastewater white. Meat processing or packing plants can discharge blood and other animal by-products which cause color changes in the influent. Not all industrial discharges are harmful to plant operation, but any color other than normal should be investigated.

### **Good Operation: Light colored foam, chocolate brown mixed liquor**

Foam, mixing patterns and activated sludge color in the aeration tank can also be used to indicate either good or poor operation. A crisp, light-colored foam, along with a well-mixed milk-chocolate-brown liquid in the aeration tank indicates healthy micro-organisms and a well-operated plant.

### **Young Sludge: Billowing white foam, light brown mixed liquor**

Excessive billowing white foam and a light brown mixed liquor usually indicate a young sludge. A thick, dark and greasy foam with a dark brown mixed liquor can almost always be traced to old sludge. These conditions indicate that a problem exists and that a poor quality effluent is probably being discharged.

### **Old Sludge: Thick, dark, greasy foam, dark brown mixed liquor**

### **Mixing Pattern**

Violent turbulence accompanied by larger bubbles (a diameter of one-half inch or greater) is usually; a sign of over-aeration or a broken aerator. This may cause floc shear (breaking up of the solids) and the creation of a poor settling sludge. On the other hand, dead spots usually indicate under-aeration or plugged diffusers which result in poor mixing and may lead to septic conditions in the tank.

**Sludge Blanket Depth:  
One-fourth the depth  
of the clarifier**

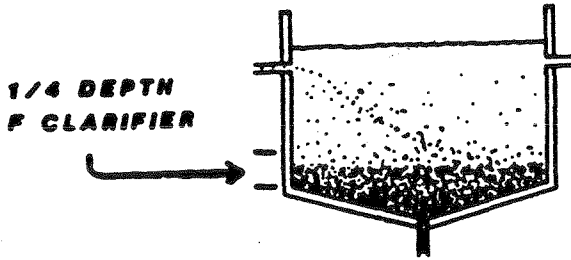

**Clear Effluent**

## **AERATION CONTROL**

**Dissolved Oxygen Test**

Final clarifier observations can also be helpful in determining problems. A sludge blanket will develop in the clarifier. This sludge blanket is formed by the settled sludge which forms a distinct interface with the clear liquid above it. The sludge blanket should not be allowed to rise above one-fourth the depth of the clarifier. A higher sludge blanket may mean either too slow a return rate or too many solids in the system.

The return sludge should be observed at least daily. Check for proper flow and for abnormal colors or other characteristics.

The effluent should be observed daily for clarity.

These observations help an operator determine whether the treatment facilities are operating properly or whether problems exist. They may also indicate what the problems are or what controls and changes are needed to improve plant operation. But usually, by the time problems can be observed in the system, the effluent has already been affected. Control tests, however, are a more accurate method of control since they can indicate problems in their early stages, before they are readily observable and the effluent quality has deteriorated.

### Control Tests

The dissolved oxygen (DO) test is used to ensure that a proper aerobic environment is maintained for the micro-organisms. Because activated sludge treatment is an aerobic process, the micro-organisms require oxygen. Therefore, it is important that there is always enough oxygen in the aeration tank. Normal DO ranges in an aeration tank should



be between 1 to 2 mg/l. If there is not enough oxygen (less than 0.5 mg/l), the micro-organisms may suffocate resulting in poor sludge settleability. Dissolved oxygen concentrations should be checked periodically (at least once a day) so that air rates can be adjusted if necessary. Also, the dissolved oxygen concentration should be measured at different locations in the aeration tank and at different times during the day to ensure that adequate dissolved oxygen is present throughout the tank at all times. The head end of the aeration tank in the afternoon is usually the most critical location and time.

#### **WASTING RATE CONTROL**

Solids control in an activated sludge process is at least as important as dissolved oxygen control. The micro-organisms will perform better and form floc which will settle to produce a high quality effluent if their numbers are maintained at the right concentration. Too many micro-organisms in the system for the incoming amount of food (BOD) will starve some of them and also result in some going out the effluent as solids. But when too few micro-organisms are present, not all of the food will be removed which will end up in the effluent as BOD.

Control of solids to maintain the right amount of micro-organisms will produce the highest quality effluent. Control of the solids in the system is accomplished through proper return sludge rates and waste sludge rates. The following tests can assist in determining the proper return and wasting rates to control solids concentrations.

### Centrifuge (spin) Test

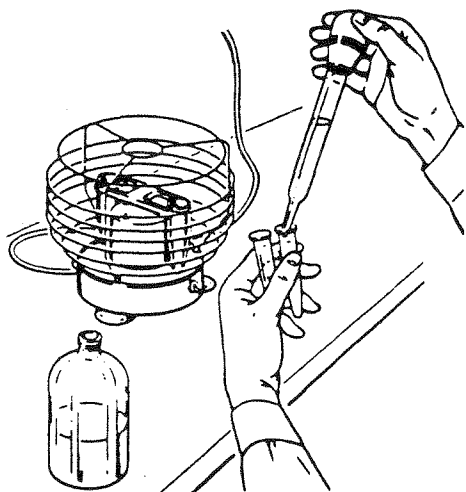

The centrifuge test (spin test) is a quick method of estimating sludge or micro-organism concentration. To be a real benefit, the centrifuge test must be run several times each week. The centrifuge test results should be maintained at a level which produces a good effluent. A good range for the centrifuge test is usually 0.3 to 0.8 ml of solids in a 10 ml tube. It is up to the operator to determine at what centrifuge test result the treatment facility produces the best effluent and then try to maintain the plant at that level by a proper wasting schedule. High centrifuge test results usually mean too many micro-organisms and sludge wasting should be increased.

### Settleability Test

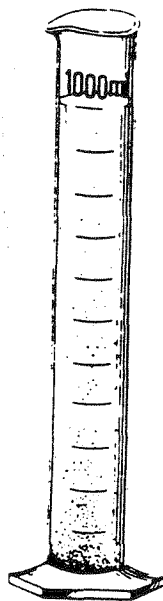

The settleability test is another control test which is easily performed and should be run daily. Performing the settleability test on the mixed liquor will tell whether there is proper aeration in the aeration tank and good settling in the clarifier. The only equipment needed is a 1,000 ml graduated cylinder.

Fill the cylinder to the 1,000 ml mark with mixed liquor and let it stand in a quiet, vibration-free area. Wait five minutes, then check the settling. The sludge should have settled to between 500 ml and 700 ml (50 and 70 percent). After 30 minutes, take another reading. The sludge should now have settled to somewhere between the 200 ml to 500 ml marks (20 and 50 percent). NOTE: These are typical ranges and will vary from plant to plant. If results are greater than these values, probably too many solids are being maintained and more sludge should be wasted. After settling

for 30 minutes, the supernatant above the sludge should be clear and free of suspended solids. The settled sludge should be a milk-chocolate-brown color.

If the supernatant in the cylinder is turbid and the sludge is odorous and black, the aeration tank is not receiving enough air. When the sludge in the cylinder has a reddish color or rises in the cylinder within an hour, it could indicate over-aeration.

### Settleometer Test

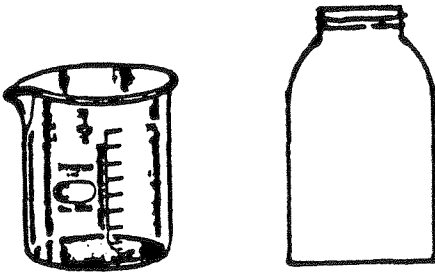

The settleometer test is another control test which indicates good or poor settling. If used at least twice a week, it can forewarn of a need for an operational changes before the plant becomes upset. The only equipment needed is either a settleometer beaker or any two-liter container such as a large pickle jar with appropriate graduations added. By pouring in 100 ml at a time and marking each level with a piece of masking tape, these graduations can be added to a two-liter container.

Pour a well-mixed sample of mixed liquor from the aeration tank into the container. For the next hour, plot a settling curve on graph paper, taking readings of the settled sludge level every five minutes for the first half-hour and every ten minutes for the last half-hour. The following diagram indicates an ideal curve for a properly operating plant.

### Good Settling Sludge

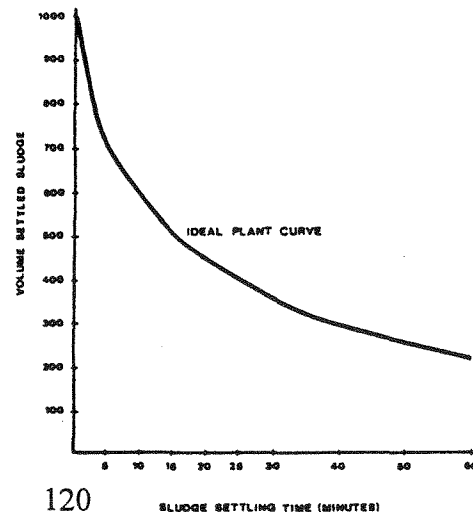

Good operation is also indicated by a clear supernatant, good settling, compaction and proper color of the sludge. Once this curve has been met, it should be maintained by proper operational control.

When the plotted curve starts rising above the ideal as shown below, it may be an indication of either: 1) a slow settling sludge; 2) not enough sludge; or 3) too much sludge. Young, slow settling sludge, or not enough sludge, will be accompanied by a light greyish to tan-colored sludge and a turbid supernatant with large floc in it. Conditions which can cause this are too much wasting and high organic or hydraulic loadings. This situation can be controlled by decreasing wasting and temporarily increasing return rates.

### Slow Settling Sludge

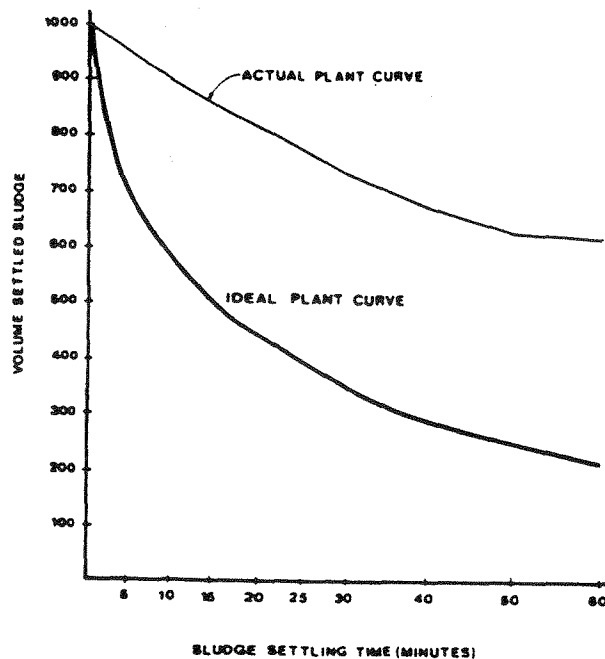

A rising curve can also be caused by too much sludge. In this case, a darker brown sludge and a fairly clear supernatant with some small suspended floc will be seen in the settleometer. The best method of double-checking

whether there is too much sludge or too little sludge is by use of the dilution method. By diluting the mixed liquor in the settleometer 50 percent with plant effluent and by plotting a new curve, the exact sludge condition can be determined. If the sludge settles much better after dilution, producing a curve similar to the ideal curve or a fast settling curve (described below), it indicates excess sludge. Wasting should be increased in this case. If the sludge does not settle out even after dilution, it indicates that more microorganisms are needed and wasting should be decreased. This 50 percent dilution technique can also be applied to the 1,000 ml graduated cylinder test if the 30-minute test result is above 500 ml.

When the curve drops below the ideal as shown below, it indicates a fast settling sludge (too many microorganisms).

### Fast Settling Sludge

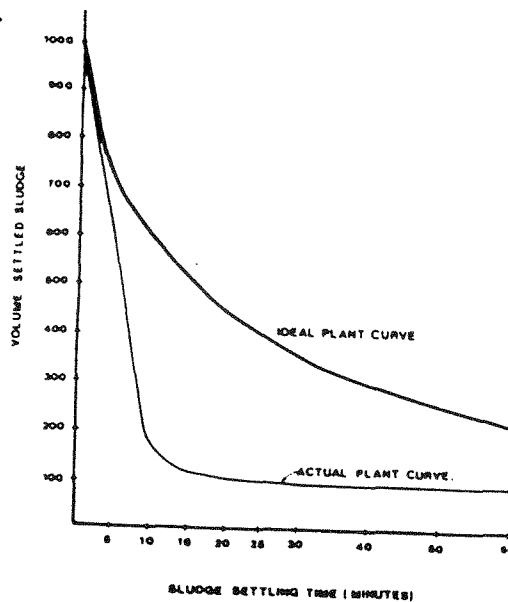

Conditions which cause this type of curve are: not enough wasting, low organic loadings or too high a return rate. Solutions to this problem are to increase wasting and/or reduce the return sludge rate.

Graphing the results of these tests on a trend chart over a period of time will provide better control over what is going on in the plant by simply observing the different trends.

## RETURN RATE CONTROL

### Settleability on Return Sludge

**Under 900 ml:  
Decrease Return**

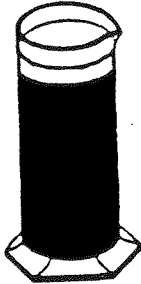

**Over 980 ml:  
Increase return**



The third controllable parameter is the return sludge rate. There are process monitoring techniques which can easily be used to determine how to control the return sludge rate. Two of these techniques are return sludge settleability and sludge blanket monitoring. Return sludge settleability is determined by conducting a 30-minute settleability test on a return sludge sample. This test is similar to that described above for the aeration tank (using a 1,000 ml cylinder) except the sample is run on return sludge. After 30 minutes, the sludge should have settled to somewhere between 900 and 980 ml (90 and 98 percent). Results below 900 ml indicate that too much water is being pumped with the return sludge and that the return rate should be decreased. Results above 980 ml indicate that the return rate should be increased.

Checking the sludge blanket is one of the most direct methods of determining proper return sludge rates. Sludge blanket depth refers to the depth of sludge in the clarifier. Methods used to measure sludge blankets include sight tubes, core samplers and electronic sensors. These measurements should be taken at the same time each day during the maximum flow period when the clarifier is receiving the highest solids loading.

## SLUDGE BLANKET FINDERS

The depth of the sludge blanket in the clarifier should be less than one-fourth that of the sidewall depth. For example:

If the clarifier sidewall depth is 10 feet, the sludge blanket should not be more than 2.5 feet deep.

Too high of a sludge blanket may indicate an inadequate sludge return rate. Too low of a sludge blanket depth may indicate that the sludge return rate should be decreased.

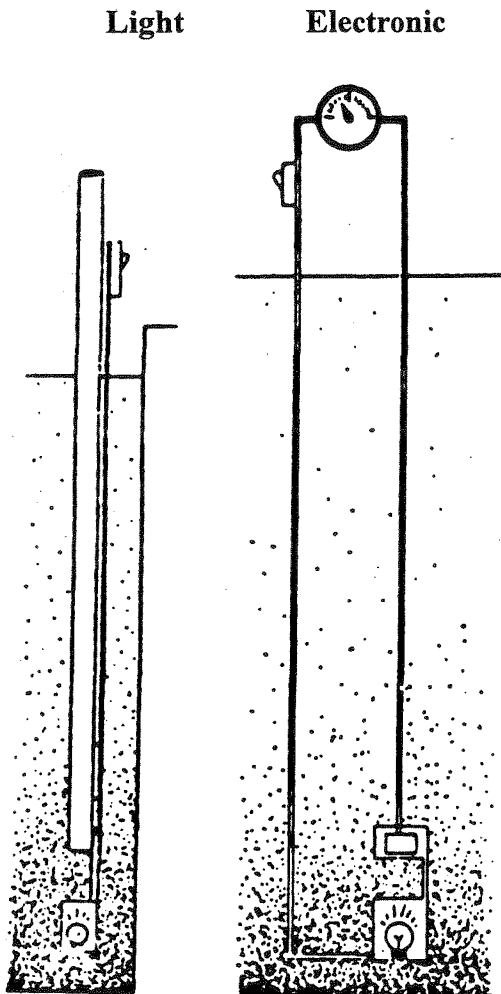

It is important to remember that an increasing sludge blanket depth may also be the result of either too much sludge in the system or a poor settling sludge. In either case, increasing the return sludge rate might not help. Other factors must be examined, such as wasting or changing the micro-organisms environment. The settleometer test will aid in determining the proper course of action. Increased blanket depth may also indicate mechanical failure such as plugged pumps, piping or broken sludge collectors.

In most small package plants, the return sludge flow rate is set by the operator and not frequently changed. During peak daily flows when more food enters the plant, this constant return rate can be a disadvantage to the plant's operation. During these times, the constant return rate may not be high enough. This may result in too many micro-organisms accumulating in the final clarifier and not enough in the aeration tank to handle the increased food load. One method of controlling plant efficiency during this situation is

to increase the rate of return sludge during the day and reduce it at night. This will help to make certain that there are enough, but not excessive, micro-organisms in the aeration tank at all times.

## Temperature

Temperature in the aeration tank is another operational parameter which is important, although often forgotten. The micro-organisms work best at a temperature range of 15° to 35°C. At temperatures lower than 15°C, they do not function efficiently. To compensate for this inefficiency, two approaches can be taken -- short-term and long-term controls.

Since the micro-organisms slow down their activity when they get cold, it will take more of them to do the same job. During the fall months, the micro-organism population must be gradually increased as the aeration tank contents get colder. In other words, solids must be increased. This is done by a gradual decrease in wasting. During the spring, as the aeration tank contents warm up, the micro-organism population must be decreased by gradually increasing the wasting. Control tests and observations discussed above will indicate this need for adjustment in the wasting rate as well as the return and aeration rates. Solids adjustment may be merely a short-term control since each plant modification is designed to handle only a specific maximum number of micro-organisms. When too much sludge builds up, it will wash out with the effluent. Therefore, a cover may be necessary for long-term temperature control when temperatures in the aeration tank fall below 15°C for long periods of time. By covering the aeration tank, enough heat



may be retained to keep the micro-organisms active and to eliminate the necessity of building solids in the colder months.

All control tests must be run often enough to note even the slightest changes in the operation of the treatment facility. If a problem can be noted and checked in its early stages, an operator can prevent a potential upset from becoming a real one. For example: a settleometer test shows gradually slower settling sludge over a two-week period. If changes are made in the wasting rate when this trend is first noticed, the operator will have prevented this problem from developing to the point of deteriorating the effluent.

Any change made in the aeration, return or wasting rates should be small. Test results should be observed for at least one week before making any further changes to ensure that the correct change was made.

Good operation means control. By controlling the air, return and wasting rates, a high quality effluent should be expected from the treatment facility.

## MAINTENANCE

Good housekeeping and preventive maintenance are necessary to ensure that the facility will last longer than its designed life. Maintenance should be implemented in a manner which prevents emergencies and/or unscheduled shut-downs. By keeping equipment, buildings, and grounds neat and orderly, the owners of a wastewater treatment facility will see their financial investment being used wisely.

The key to good housekeeping and preventive

maintenance is to establish a routine schedule of daily operations. This schedule should include inspection of mechanical equipment, buildings and grounds.

Because electrical equipment has gained a reputation for reliability and durability, it often goes unattended until serious problems develop. Since almost all critical equipment in an activated sludge plant is run by electric motors, they should receive close attention and care. The main rules which apply to electrical equipment are to keep it clean, dry, tight and friction-free. This applies to pumps as well as blowers.

Positive displacement blowers require periodic lubrication. Dust and impurities may build up on the lobes within the blower if intake filters are not maintained and cleaned. If the machine tends to drag or seize up, the lobes may be cleaned with a solvent. If problems still exist, the bearings are probably worn.

Turbine or centrifugal blowers are more common in larger installations. They run at higher speeds and are less noisy than positive displacement blowers. Manufacturers' manuals should be consulted for lubrication schedules, flow and rotor balancing, and noise control.

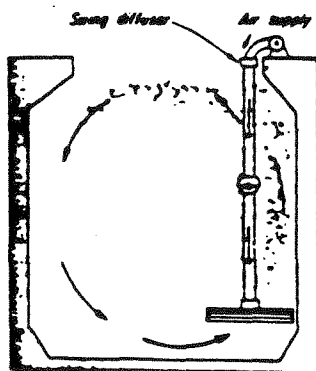

Dirty air or wastewater with high amounts of sand, iron, calcium, or magnesium hardness may clog fine bubble diffusers rapidly. Tube diffusers are usually mounted on “swing” arms which can be removed without draining the basin. Dirty tubes should be flushed with water, presoaked in strong detergent and rinsed.

Large bubble diffusers such as the air jet, sparger and perforated pipe types are relatively maintenance free.

### COARSE BUBBLE DIFFUSERS

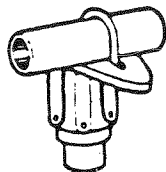

OPEN PIPE DIFFUSER

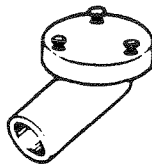
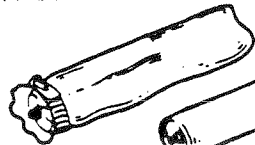

PLATE DIFFUSER

### FINE BUBBLE DIFFUSERS



CLOTH TUBE



SARAN-WRAPPED TUBE

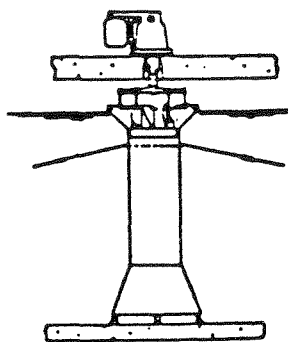

However, at times they may plug and need cleaning. Some slime and deposits may be dislodged from a plugged diffuser by increasing the air volume through it for a short interval. This can be accomplished by increasing the blower capacity or throttling other air diffusers.

Unless the wastewater contains abnormally high concentrations of slime-producing minerals, or the diffusers are turned off frequently, there is little other maintenance associated with this type of diffuser.

Mechanical aerators are usually floating or fixed platform types. These units require the normal maintenance assigned to motors, bearings and gear reducers. Close attention must be paid to providing proper alignment and secure mounting because of vibrations caused by subsurface currents.

In areas with severe winter weather, some mechanical aerators experience problems with ice build-up. These units may require ice shields or external heat to protect them from ice damage.

All equipment should be checked for unusual noise, heat or vibrations daily. Equipment should be lubricated according to manufacturers' recommendations and kept clean and painted. Walkways around the tanks and equipment should be kept free of grease and other debris. It is especially important to wash down any foam which has splashed onto the walkways around aeration tanks. This foam is not only slippery, but can carry pathogenic organisms which may cause infections.

Building inspection includes ensuring that buildings are clean and neat at all times. Ground maintenance includes

mowing grass in the summer as well as snow shoveling and plowing in the winter. It is also important to keep all fences, gates and locks in good repair and working order. One of the most important functions of ground maintenance is to make the plant attractive. The addition of a few flowers, trees and shrubs can make the plant more acceptable to surrounding neighbors and citizens of the community.

Remember, first impressions are lasting impressions. All operators benefit from keeping their facility well-maintained and attractive.

## REFERENCES

1. Operators Pocket Guide to Activated Sludge: Part I - The Basics, Part II - Process Control and Troubleshooting, Stevens, Thompson and Runyan, Inc.
2. Operation of Wastewater Treatment Plants - A Field Study Training Program, California State University, Sacramento.
3. Operational Control Procedures for Activated Sludge Process, U.S. Environmental Protection Agency.
4. MOP 11 - Operation of Wastewater Treatment Plants, Water Pollution Control Federation.
5. Aerobic Biological Wastewater Treatment Facilities, Office of Water Programs Operations, U.S. Environmental Protection Agency.
6. Package Treatment Plants Operation Manual, U.S. Environmental Protection Agency.
7. Activated Sludge Package Plant Operation Manual, Minnesota Pollution Control Agency.

# STABILIZATION PONDS

## TABLE OF CONTENTS

	<u>PAGES</u>
<u>INTRODUCTION</u>	132
Advantages	
Disadvantages	
<u>THEORY</u>	133
Symbiotic Cycle	
Effects of Wind	
Influence of Light	
Influence of Temperature	
Diurnal Fluctuations	
Winter Conditions	
<u>DESIGN</u>	139
Types of Ponds	
Factors Which Affect Design	
Loading	
Storage Capacity	
Multiple Units	
Location	
Seals	
Fencing and Signs	
<u>OPERATIONS</u>	142
Series Operation	
Parallel Operation	
Discharge	
<u>MAINTENANCE</u>	145
Vegetation Control	
Erosion	
Burrowing Animals	
Seepage	
Sampling and Laboratory Control Tests	
<u>REFERENCES</u>	148

**Ponds are Not Just a  
Hole In the Ground**

INTRODUCTION

The use of stabilization ponds as a method of treating domestic and industrial wastewater is relatively new when compared with other forms of treatment. However, the use of ponds has progressed to the point such that when properly designed, constructed and operated, a stabilization pond will produce an effluent well within standards.

Stabilization ponds are a method of secondary treatment in which natural purification processes occur under controlled conditions. A stabilization pond is not just a hole in the ground, but is a carefully designed treatment facility.

Both the conventional mechanical wastewater treatment plant and the stabilization pond accomplish the same end result which is the protection of our streams and lakes from degradation resulting from the discharge of untreated wastewater.

The first municipal ponds were developed in 1928 from existing natural ponds. The success of these and many others now in use nationwide has led to the wide acceptance of a stabilization pond as a satisfactory method of wastewater treatment. The first pond system in Minnesota was built in Albany in 1955.

Stabilization ponds are usually constructed in smaller communities because their advantages greatly outweigh their disadvantages.

Advantages

- controlled seasonal discharges
- lower construction/operation costs

- surge (excessive) flow is readily accepted
- low chemical and energy consumer
- very little (if any) sludge disposal problems
- adaptable to land application of final effluent
- lower mechanical failure potential
- potentially increased design lift
- wildlife habitat

#### Disadvantages

- possible odors in the spring
- larger land usage
- operations dependent on climatic conditions
- maintenance needed during busy times of year
- possible ground water contamination
- potential for higher suspended solids

#### THEORY

**Home  
Food  
Micro-organisms  
Oxygen**

A stabilization pond is considered the home in which micro-organisms live and break down organic matter.

Ponds in Minnesota are generally described as aerobic ponds. Actually, aerobic, facultative and anaerobic conditions all exist in a normal pond system at various locations and times. The types of micro-organisms which predominate in a pond are relative to the type of oxygen available in the system.

**Dissolved Oxygen (DO)**

The organisms which only use dissolved oxygen (DO) for their life processes are called aerobic, whereas anaerobic organisms exist with no free DO only use combined oxygen for their life processes. Facultative organisms are capable of

**Combined Oxygen**



using either dissolved or combined oxygen. They can adapt to changing oxygen conditions (aerobic to anaerobic or vice versa) and continue decomposition of organic matter.

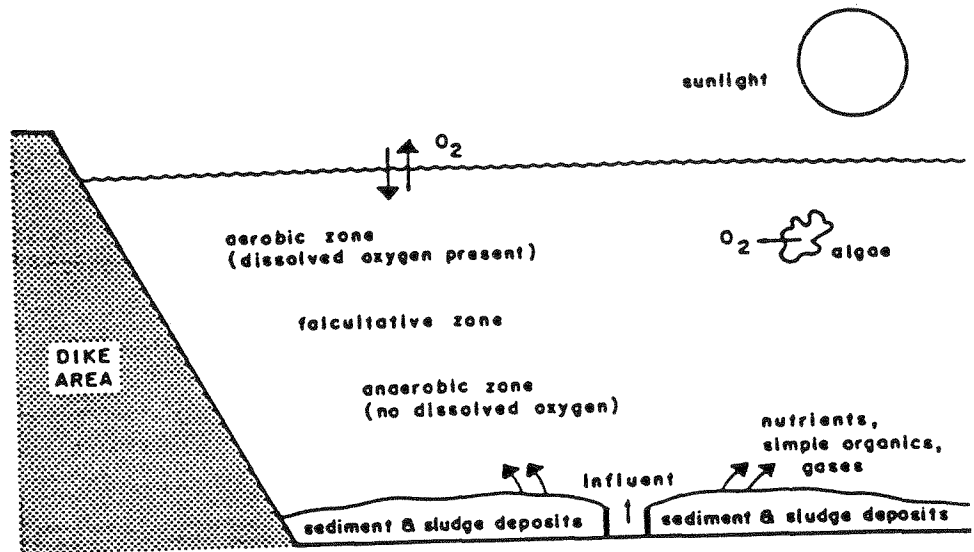

The extend of the aerobic zone in a pond fluctuates with many environmental factors. For example, during summer months with maximum oxygen production from algae and surface wind action, the aerobic zone may approach the entire depth of a pond. However, during winter when oxygen is depleted because of ice and snow cover, the anaerobic zone may occupy the entire pond.

### Sludge Layer

The sludge layer (in a balanced pond system) is anaerobic. Gas and other by-products are produced during anaerobic decomposition. In the summer they are adsorbed and/or broken down by aerobic organisms before they escape to the atmosphere and in the winter they are trapped under the ice.

**ALGAE:** One or many-celled plants, usually aquatic, that contain chlorophyll, and have the same basic requirements as any plant.

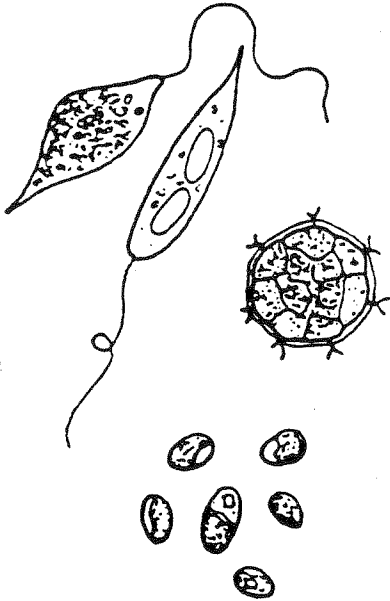

Typical Algae

**RESPIRATION:**

The process by which a living organism or cell takes in oxygen from the air or water

Symbiotic Cycle

Wastewater stabilization in a pond during the summer is accomplished by a complex community of micro-organisms. The phenomenon of stabilization is a result of the mutually beneficial or symbiotic relationship between bacteria and algae. This mutually beneficial interaction is called the symbiotic cycle.

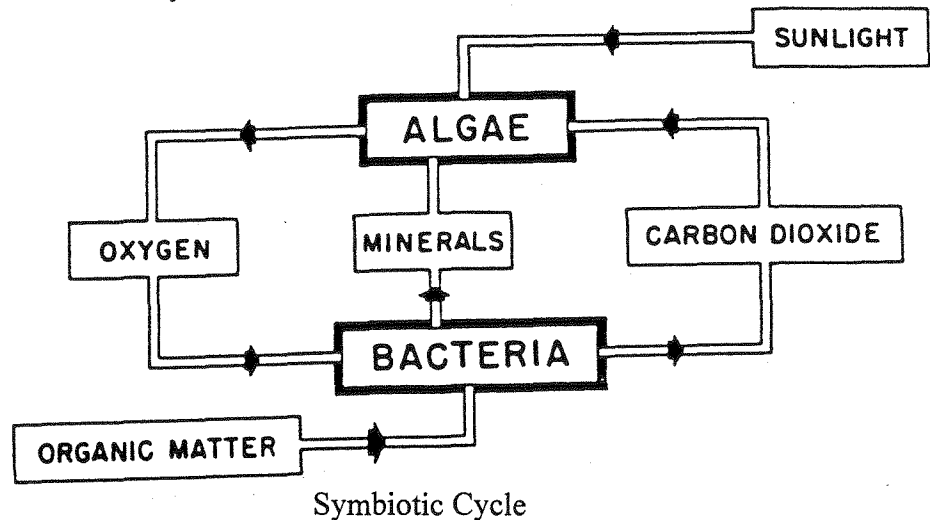

In the process of biological oxidation, organic compounds are partially or completely oxidized by micro-organisms to carbon dioxide and water. The use of dissolved oxygen by bacteria and other micro-organisms is called aerobic respiration.

Through photosynthesis, algae produce the dissolved oxygen which helps to maintain an aerobic system. Algae are microscopic plants which swim or float and are either unicellular or colonial. They are also known as phytoplankton. These organisms, although extremely minute, can form masses or colonies in sufficient quantity to give the ponds a greenish color.

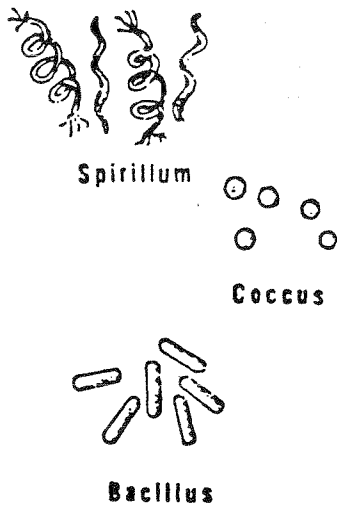

**Typical Bacteria**

The stabilization pond process converts most of the unstable organic matter in wastewater to a more stable algal mass. Most of the wastewater solids in the form of sludge, bacterial mass, and algal mass eventually accumulate on the bottom of the primary and secondary ponds in the form of a thin gelatinous layer of mud or sludge. Through the process of anaerobic decomposition, this sludge layer will be decomposed so that sludge removal during the design life of a system will not be required.

**Wind**

Effects of Wind

During the summer months, the major source of dissolved oxygen added to a stabilization pond is not by wind action (which many people assume), but by algae. The major benefit of wind action is that it provides mixing of the pond contents. This mixing provides for maximum use of the DO produced by algae and also allows for better contact between the bacteria and organic material.

During the spring, fall and at any other time when the dissolved oxygen concentration is less than the saturation point, oxygen is absorbed at the surface.

**Sunlight**

Influence of Light

Sunlight is indispensable to the stabilization process because it is necessary for the growth of algae and the production of oxygen. The duration and intensity of sunlight determines how effectively a pond will operate. The variation in the amount of solar radiation which is governed by latitude, elevation, annual cloud cover and seasonal

change affects the amount of solar energy received by a pond.

The depth of penetration of effective sunlight is normally limited to less than six feet. Because algae growth is dependent on this solar energy (sunlight), stabilization ponds are designed to a maximum of six feet.

## Temperature

### Influence of Temperature

Sunlight and seasonal weather changes affect temperature of the pond water and the stabilization process. Water temperature influences several areas within this process. They are:

- 1) the rate at which biochemical oxygen demand (BOD) is reduced;
- 2) algae species and density;
- 3) bacterial activity;
- 4) algal respiration rate; and
- 5) the dissolved oxygen (DO) saturation point.

The first four listed above usually decrease with decreasing temperature; however, the dissolved oxygen saturation point increases with decreasing temperature.

**SATURATION: When the water holds as much dissolved oxygen as possible at the given temperature.**

### Diurnal Fluctuations

The changes in solar radiation and air temperature over a 24-hour period also cause daily variations in pond temperatures, dissolved oxygen concentration, pH, and other characteristics. Daily highs in dissolved oxygen may be 300 percent of saturation, while nighttime lows may

approach or reach zero. Diurnal fluctuations of pH, sometimes reaching highs of pH 10, are related to carbon dioxide usage during photosynthesis.

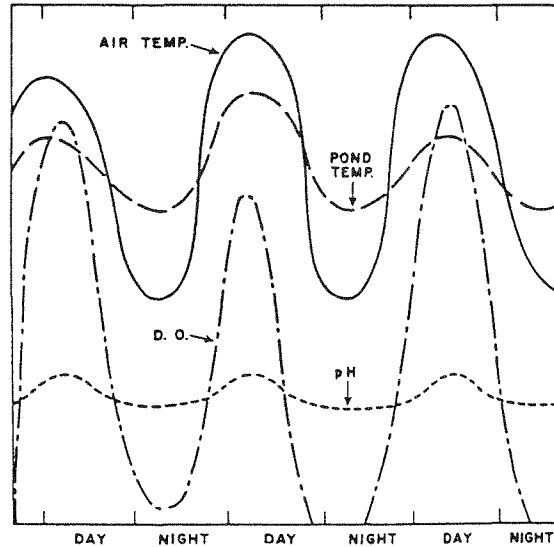

Daily Fluctuation in a Pond

**Anaerobic  
Decomposition**

Winter Conditions

During the winter, under ice and snow cover, no oxygen is produced because of lack of sunlight; the absorption of oxygen from the atmosphere is also completely shut off. Therefore, since dissolved oxygen is not available for aerobic decomposition, anaerobic decomposition of solids occurs. Anaerobic decomposition takes place at a slower rate because of the lower temperature of the wastewater in a pond.

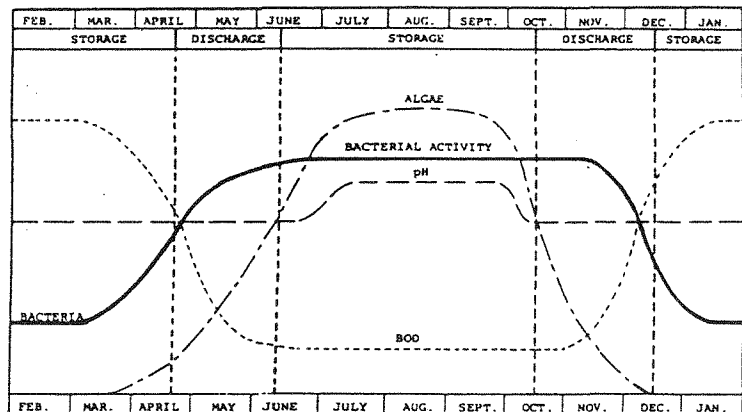

Yearly Variation in a Stabilization Pond.

During this winter period, a large portion of BOD is stored in the sludge layer and will be treated when the ponds return to the active summer period.

## DESIGN

### Types of Ponds

A pond is a man-made facility of earthen construction which is designed to standardized size, shape and depth specifications. Its design purpose is to treat wastewater prior to discharge of the effluent. Because of the many different applications of ponds to date, it is important that we define the different types of ponds to avoid confusion in later discussions.

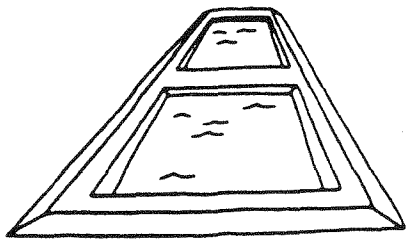

**Stabilization Pond**

A stabilization pond is a man-made facility in which the natural purification process occurs under controlled conditions. It is a secondary treatment facility designed to reduce the solids and biochemical oxygen demand of the wastewater by settling and bacterial decomposition. During the summer months, the dissolved oxygen required by the bacteria is primarily supplied by algae living with the pond.

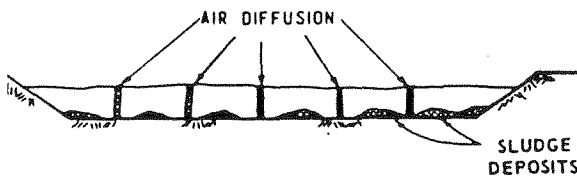

**Aerated Ponds**

Aerated stabilization ponds use the same basic concept as a stabilization pond. However, an aerated stabilization pond uses mechanical or diffused aeration to supply oxygen to the system.

### **Polishing Ponds**

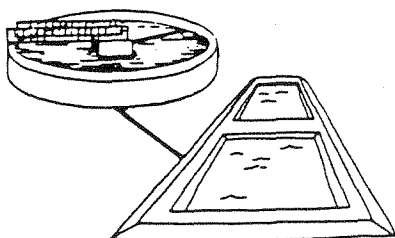

Effluent polishing ponds are designed like wastewater stabilization ponds except for generally shorter detention times. They usually follow a secondary treatment process and are designed to provide additional removal of BOD and suspended solids. Effluent polishing ponds have lower organic loading rates than stabilization ponds.

**EFFLUENT SEEPAGE  
PONDS: A form of  
land application**

Effluent seepage ponds are considered a form of tertiary treatment where the final effluent is further purified by the soil.

**Waste Storage Lagoons**

Industrial waste storage lagoons are used for temporary storage of wastes from processing operations such as vegetable canneries, sugar beet processing plants, etc. The waste stored in these systems is generally of high strength and often times associated with odor nuisances. Treatment does not usually occur in the lagoon but is later accomplished through other processes, such as land application, chemical addition, etc.

Factors Which Affect Design

Design criteria for waste stabilization ponds vary throughout the United States. Some of the factors which affect pond design are total area, loading, depth, storage capacity and climatic conditions. The most important design factors are the loading and climatic conditions. The climatic conditions in the north dictate that the organic loading be less than that of areas further south and west.

**22 lb BOD/ACRE/DAY**

Loading

Generally, one acre of water surface is provided for each 100-120 design population or population equivalent. In terms of BOD, a loading of approximately 22 pounds of BOD per day per acre of surface area should not be exceeded.

**Detention Time --  
Minimum of 180 Days**

Storage Capacity

Since treatment efficiency is greatly reduced during the period of ice cover (about six months in Minnesota), the ponds are designed with a minimum of 180 days storage capacity. Storage capacity is calculated to include the volume between the two-foot liquid level and the maximum liquid level, not to exceed six feet in the primary and secondary cells. Pond dikes are designed with three feet of freeboard above the maximum liquid level and with a gentle slope on the inside to minimize erosion at the water line.

Multiple Units

Stabilization ponds are designed with both a primary cell and a secondary cell. The primary cell should be divided in tow and arranged for both series and parallel operation, permitting flexibility of operation.

The secondary cell hydraulic capacity should be at least one-third that of the entire system. Secondary cells are designed to operate in series with the primary cell(s).

Location

Much of the controversy surrounding the location of a wastewater treatment facility, particularly stabilization ponds, is based on aesthetic consideration. Therefore, due consideration should be given to its location. Ponds should be located a minimum of one-quarter mile from any dwelling.



### Seals

Ponds should be sealed to retain wastewater and reduce the potential for ground water problems. Usually seals are a minimum of one foot thick and constructed of compacted clay materials. However, other types of seals such as vinyl liners and incorporated bentonite are sometimes used.

### Fencing and Signs

The pond area should be enclosed with a fence adequate to keep out livestock and to discourage trespassing. A vehicle access gate should be provided to accommodate mowing equipment. All access gates should be equipped with locks.

Signs must be posted at a maximum of 500 feet apart along the fence to designate the nature of a facility and to forbid trespassing.

An all-weather access road to a pond should be provided for accessibility during periods of inclement weather.

### OPERATIONS

Stabilization ponds are designed to have a holding capacity of a minimum of 180 days. Because of this, discharging is usually done once or twice a year, during the spring runoff and/or late in the fall. It is not always necessary to discharge the total pond system volume every 180 days. The volume to be discharged should be based on the capacity required to store the next 180-210 days flow to the system.

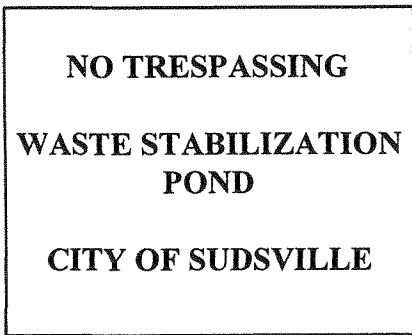

**Typical Sign**

This is especially important for systems in which actual flow is much less than the design flow. Discharging no more than the required storage capacity is important because water assists in the overall treatment process and in protection of a facility. For example, water discourages vegetative growth, protects the seal, provides dilution, and permits a greater biomass volume. Excess water may encourage erosion which should be kept in check at all times.

The operation of a pond requires proper control of water levels along with transferal of water among the cells. The goal is to fill the final cell with the “oldest water” in preparation for discharge.

There are two basic methods by which water transfer through a pond system can be regulated. They are series and parallel operation which refers to the flow schemes through the primary and secondary cells.

### Series Operation

#### Series

Wastewater is discharged to the first cell and then periodically transferred in small amounts to each of the following cell(s), one at a time.

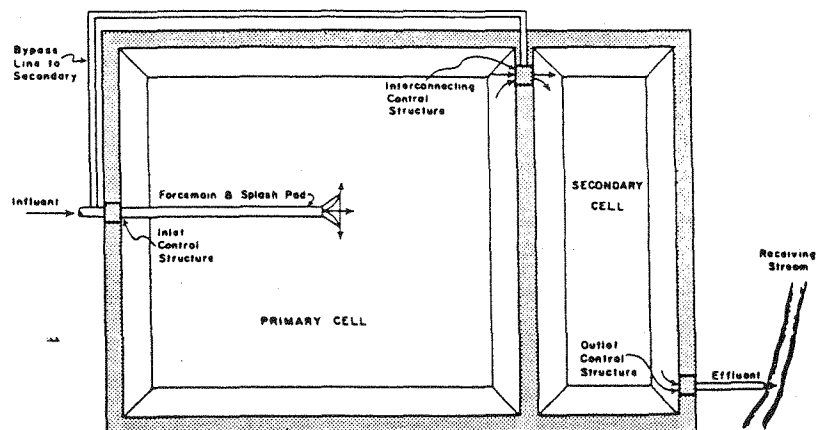

## Parallel

### Parallel Operation

Parallel operation requires discharging influent in equal amounts to the primaries. This is accomplished by either splitting the flow or alternating discharge from one cell to the other in equal volumes. The oldest water is then transferred to the secondary cell. Pond discharge standards can only be met if preparation for discharge is made through proper water transfer operations.

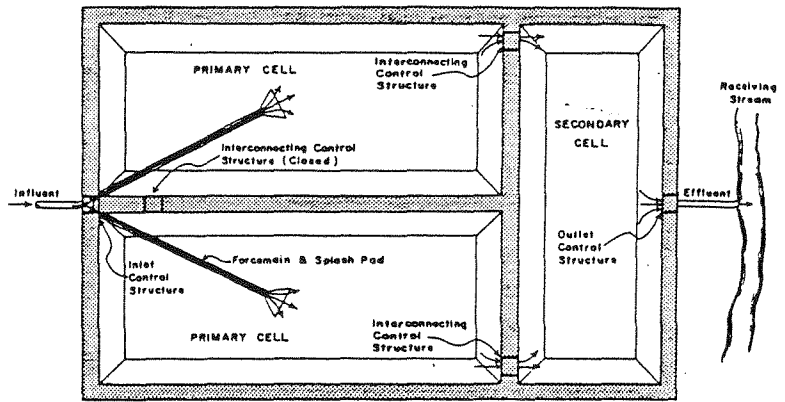

Parallel Operation of  
Multi-Celled Primaries

## Series or Parallel

Multi-celled pond systems have the flexibility to be operated in series or parallel operation.

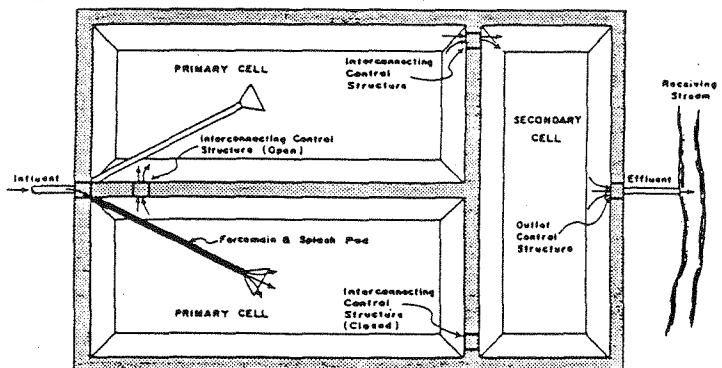

Series Operation of  
Multi-Celled Primaries

**Discharge only enough  
water to provide  
180 days of storage**

### Discharge

Discharge of a wastewater stabilization pond should occur during the spring and/or fall, or nonrecreational times of the year. The first step taken by a pond operator is to determine whether a discharge is necessary to provide accurate summer or winter storage. If not, the ponds should not be discharged.

The following guidelines outline the procedure to be followed when discharging wastewater stabilization ponds:

- 1) Determine whether a discharge is necessary and the amount of discharge.
- 2) Sample the secondary cell prior to discharging.
- 3) If required, discharge notification after the sample results are received.
- 4) Discharge slowly (a maximum of six inches per day).
- 5) Sample the effluent twice a week during its discharge.
- 6) Report the results on the monthly report form.

### MAINTENANCE

#### Vegetation Control

Vegetation in ponds must be kept to a minimum. Overgrowth of weeds can penetrate a pond seal and can also create a habitat for insects. Unwanted vegetation includes submerged water weeds, marsh plants, rooted plants with floating leaves, shrubs and trees.

Rooted vegetation such as cattails and rushes are the most troublesome of the marsh plants. They usually become established in the shallow water along the edges of a pond. However, they can become a problem throughout the entire

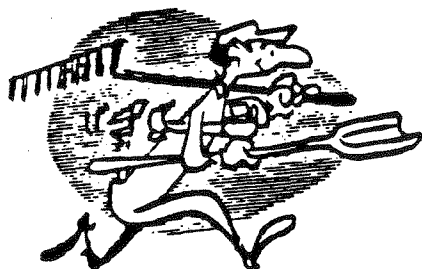

### Common Cattail

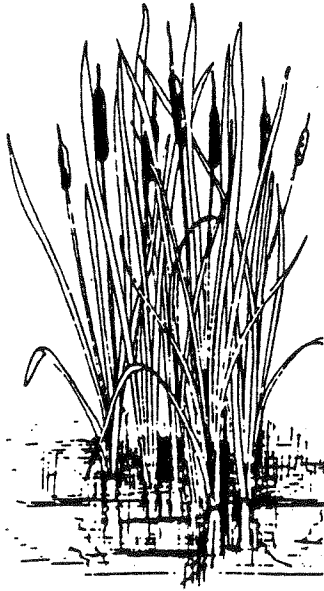

### Low-Growing Grass

pond if the water depth is not kept at a minimum of three feet during the summer. Several methods for controlling cattails are:

- 1) pulling them before they colonize and establish extended roots;
- 2) cutting them below the water line to retard growth. In order for this to be effective, the water level must be approximately three feet over the cattails after cutting;
- 3) spraying with a commercial herbicide; however, this herbicide must be approved by the Department of Natural Resources and applied exactly according to manufacturer recommendations.

### Erosion

During construction, stabilization pond dikes should be planted with low-growing grass or riprapped to prevent erosion. Preferred grasses such as perennial rye and brome have a shallow, but dense, root structure which grows easily. Reed canary grass grows submerged in shallow water thus helping to control erosion at the waterline. However, if this grass is used, special care should be taken to keep it under control by mowing down into the water.

Growth of alfalfa, willows and other plants (those with long roots) should be prevented. The roots of these plants may affect the water-holding capacity of the dikes by breaking the seal, which will eventually cause structural failure and costly repairs.

## Riprap

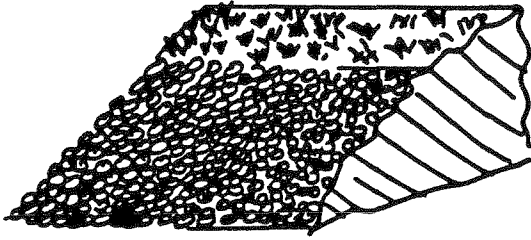

The dikes should be inspected regularly for erosion which should be repaired immediately. On large ponds, the problem of erosion may become quite serious because of wave action. Course gravel, rocks or other riprap material can be used to fill in the eroded areas. However, before any riprapping is done, check to make sure the seal is still intact.

## Muskrat



## Burrowing Animals

Dikes may be seriously damaged by burrowing animals such as muskrats, badgers and gophers. The holes of these animals may cause flooding of the surrounding property. The animals should be eliminated and their burrowed holes immediately repaired.

## Seepage

Liquid lost by seepage through properly compacted and sealed ponds should be negligible. Excess seepage can cause problems with pond operation and maintenance. Also, saturation of the surrounding land and possible ground water pollution may result from excess seepage.

## Sampling and Laboratory Control Tests

The dissolved oxygen test is the most valuable for evaluating pond operation. The DO concentration can vary from 8 to 24 mg/l throughout the summer. For other tests must be conducted, consult the NPDES permit for the facility.

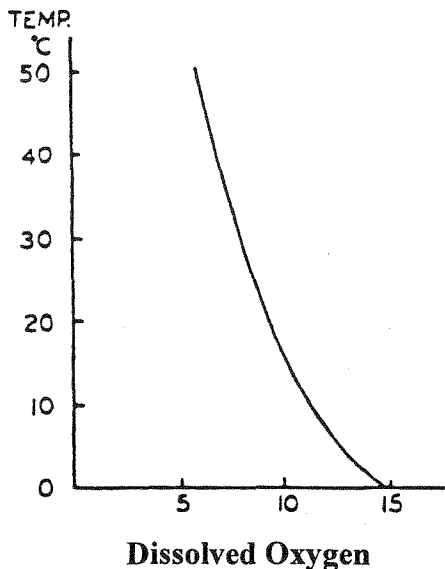

## REFERENCES

1. How to Identify and Control Water Weeds and Algae, Applied Biochemists, Inc.
2. Biology of Micro-organisms, Thomas D. Brock.
3. Operating Waste Stabilization Ponds, Eldon de Camp.
4. Waste Stabilization Ponds, D. Gloyna, F. Earnest.
5. Operation of Wastewater Treatment Plants. A Field Study Training Program, "Waste Treatment Ponds," A.L. Hiatt.
6. Waste Stabilization Lagoon Operators Manual, Iowa Department of Environmental Quality.
7. Manual of Instruction for Sewage Treatment Plant Operators, New York State Department of Health et al.
8. Water Resources Symposium Number Nine, "Ponds as a Wastewater Treatment Alternative." Austin: Center for Research in Water Resources, University of Texas.
9. Second International Symposium for Wastewater Treatment Lagoons, Kansas City, Missouri: Missouri Basin Engineering Health Council and FWQA.
10. Stabilization Pond Operation and Maintenance Manual, Minnesota Pollution Control Agency.
11. Stabilization Ponds and Lagoons, Virginia State Water Control Board, Bureau of Applied Technology, Training Division.
12. Operations Manual Stabilization Ponds, Chuck Zickefoose and R.B. Joe Hayes, Washington, D.C.: U.S. EPA, Office of Water Program Operations.

# SOIL TREATMENT SYSTEMS

## TABLE OF CONTENTS

	<u>PAGES</u>
<u>INTRODUCTION</u>	150
<u>GENERAL THEORY</u>	150
<u>TREATMENT MECHANISMS</u>	152
<u>GENERAL DESIGN</u>	155
<u>INDIVIDUAL SEWAGE TREATMENT SYSTEMS</u>	155
Sewage Tanks	
Soil Treatment Systems	
Operation and Maintenance	
<u>SLOW-RATE SYSTEMS</u>	162
Introduction	
Operation/Maintenance	
<u>RAPID-RATE SYSTEMS</u>	164
Introduction	
Operation/Maintenance	
<u>OVERLAND FLOW SYSTEMS</u>	165
Introduction	
Operation/Maintenance	
<u>REFERENCES</u>	166



## INTRODUCTION

Soil can be an excellent treatment system. As with all systems, it must be properly located, designed, constructed and operated. Mechanical wastewater treatment plants are designed to allow treatment processes that occur in natural streams to take place within the confines of the facility. Similar treatment processes will also occur in a soil treatment system.

Soil treatment systems were in use long before the invention of mechanical facilities. Misuse of soil systems lead some people to believe that they did not provide treatment of wastewater. An example of misuse includes high density single family housing using septic tanks/drainfields which has resulted in surface and ground water contamination.

Types of soil treatment systems include septic tanks/drainfields, slow rate systems (spray irrigation of domestic, industrial or agricultural wastewaters), rapid infiltration basins, overland flow and land application of wastewater sludge.

## GENERAL THEORY

Soil is a complex mixture of organic and mineral material. The pore spaces between these particles contain varying amounts of air and water. Plants and microorganisms are also present. Each item is essential to provide treatment of the waste. The amount of treatment provided depends on the soil and waste characteristics, application rate and management. The characteristics that regulate a soil's

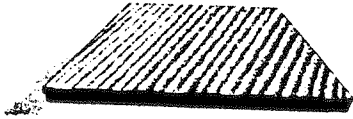

**What is Soil?**

**Characteristics**

ability to treat waste are texture, structure, permeability, organic matter content, chemical and biological characteristics, depth to a saturated zone (water table), water holding capacity, and pH.

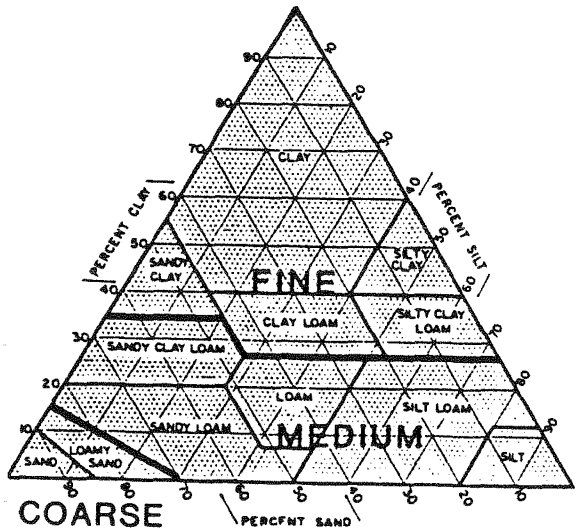

Texture is the relative percent of mineral material present. Mineral materials are sand, silt and clay size particles. Texture affects the soil’s permeability and ability to retain/filter certain contaminants in wastewater.

Structure refers to how the soil particles contact one another. Structure also affects permeability.

Permeability is the rate of movement of air and water through soil. Rapid permeability normally results in poor treatment because there is not enough contact time for treatment to occur. Permeability which is too slow can result in odor, runoff and vector attraction because the waste will remain on the earth’s surface.

Organic matter is necessary to help retain contaminants in the soil, increase water holding capacity, and provide a home for micro-organisms.

Water table - The depth to ground water or saturation - is critical for treatment. The soil atmosphere must be aerobic for many treatment processes to occur. If the soil is saturated, then it becomes anaerobic. Many soil reactions then change, resulting in undesirable end-products and slower treatment rates.

Water holding capacity is a measure of the soil’s ability to retain moisture against the force of gravity. This water is available for plant use. Texture and structure affect water holding capacity.

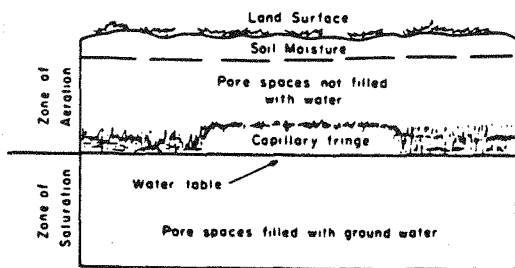

pH is also important for crop production and for retaining certain contaminants in the waste, especially heavy metals.

To understand how a soil treatment system works, one must understand how water moves through the soil.

The two basic forces which cause water to move through soil are gravity and capillary action. Most people are familiar with gravity's attraction between the earth and, in this case, water in the soil. Movement through soil by gravity usually takes place in large pores or spaces between the soil particles. This movement is called saturated flow. Gravity flow occurs when all of the soil pores are filled with water (or saturated). When water moves relatively quickly through large pores it results in poor sewage treatment.

Unsaturated flow is not commonly understood.. In unsaturated flow, only the small pores conduct water. Water moves through these pores due to capillary attraction. Capillary attraction is the force that draws water up into blotter paper or a sponge. Capillary attraction is the attraction of water particles to soil particles and to other water particles. One way to visualize this is that the small pores suck or pull water from a wet area to a dry area. The movement of water is much slower than with saturated flow. Since there is more soil contact, better sewage treatment occurs.

**SATURATED FLOW:**  
Movement of water through the soil when all the pores are filled with water; driven by gravitational forces



**UNSATURATED FLOW:**  
Movement of Water through the soil when only the smaller pores conduct water; driven by capillary forces



### TREATMENT MECHANISMS

Soil is a physical, biological and chemical filter. A properly designed and operated system can provide tertiary treatment.

## Particles are Trapped



## Plants and Micro-organisms

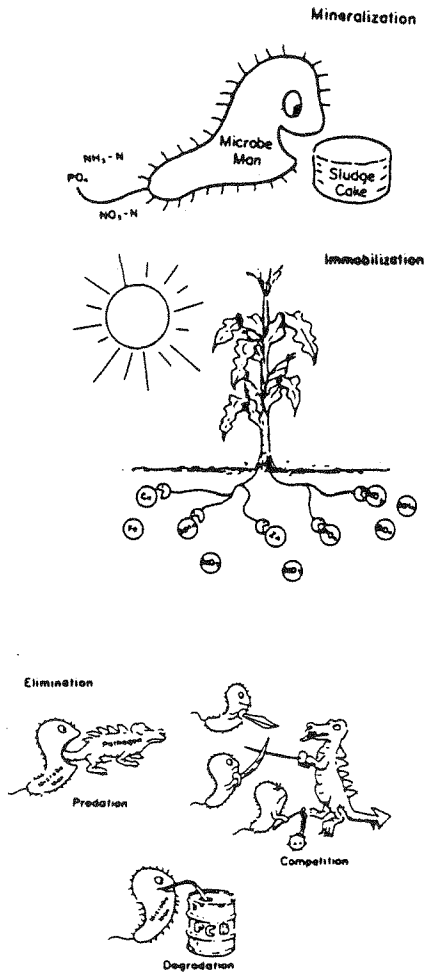

A physical filter acts as a trap. Large suspended particles are held near the soil surface where organisms, sunlight and other forces degrade the material.

Biological processes include mineralization, immobilization and elimination. These processes are accomplished by the plant and micro-organisms present in the soil system.

Mineralization is conversion of organic material to inorganic material. This is done by soils microbes consuming organic matter and releasing simple inorganic compounds. These inorganic compounds are often immobilized when they are taken up as nutrients by growing plants and other micro-organisms. Sometimes nutrients and other waste constituents are evaporated into the atmosphere or are leached into the ground water. Elimination mechanisms include: hot/cold, wet/dry environments that cause pathogen destruction; adsorption; and consumption by other organisms.

Chemical treatment processes which naturally occur in soil include ion exchange, adsorption, precipitation and acidification. Ion exchange is the same process that occurs in a water softener. Many dissolved substances have either a positive or negative electrical charge (ions). Ion exchange is the transfer of ions in the waste with ions in the soil. This process can result in adsorption or formation of a stable chemical bond between the ions. Precipitation is the formation of an insoluble solid from two or more soluble materials. Alum is often added to stabilization ponds to precipitate phosphorus. Complexation is a permanent bonding of a substance by soil humus.

## What Happens to Pollutants?

Pathogens are typically removed during unsaturated flow. Pathogens normally live and thrive in warm, moist, anaerobic environments of the digestive system. Once in the soil, they become weak from exposure to cold temperature, the presence of oxygen and the dryness of unsaturated soil. In addition, soil micro-organisms will prey on the destroy pathogens.

Nutrients are used by crops. Phosphorus is also adsorbed onto the surface of soil particles.

## Not Everything Is Removed

There are compounds which move through the soil treatment system into the ground water. These include some volatile organic compounds and dissolved inorganic chemicals which home owners improperly dump into a septic tank system. The inorganic chemicals include sulfates, chlorides and nitrogen in the form of nitrates. Once these molecules enter the ground water, the only “treatment” is by dilution.

Nitrates are of particular concern because they can cause eutrophication in lakes. High concentrations of nitrates can also cause disease in infants.

Because of nitrates, land treatment systems must be adequately separated from water supply wells and surface waters. This will allow time for nitrate dilution.

Soil treatment systems are not the only source of nitrate contamination which can occur in ground water. Nitrates can come from lawn, garden and field fertilizer, feedlots, from the breakdown of organic matter at the soil surface, or from rainfall. If a soil treatment system and drinking water well are properly designed, constructed and maintained,

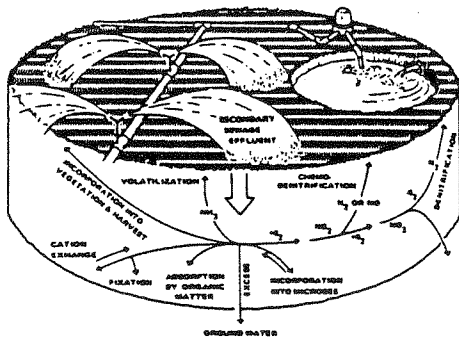

problems from nitrates in a water supply should be minimized.

### GENERAL DESIGN

Soil treatment systems must be designed to treat contaminants in the wastewater. Major design considerations include the quantity of water generated, nutrient content, BOD, suspended solids and trace/toxic element content.

Climate, soil characteristics, slope of the land, strength of a wastewater, crop grown, and operational methods also affect the treatment efficiency.

Most land treatment systems are preceded by primary settling and/or treatment storage systems. Runoff control may be provided to return excess water to the treatment system. The system can also include a distribution system which applies the wastewater uniformly over the treatment area, vegetation to consume nutrients, and monitoring points.

### INDIVIDUAL SEWAGE TREATMENT SYSTEMS

Individual sewage treatment systems are commonly used for rural single family homes and small businesses. Recently, many small communities and lakeshore areas have installed larger systems. They are also used for mobile home parks, campgrounds, resorts, and similar areas where other treatment systems are not practical.

A properly designed, constructed and maintained individual sewage treatment system can treat waste effectively for years with minimal adverse environmental impact. Additional information on design and construction

of these systems can be found by consulting the references at the end of this chapter.

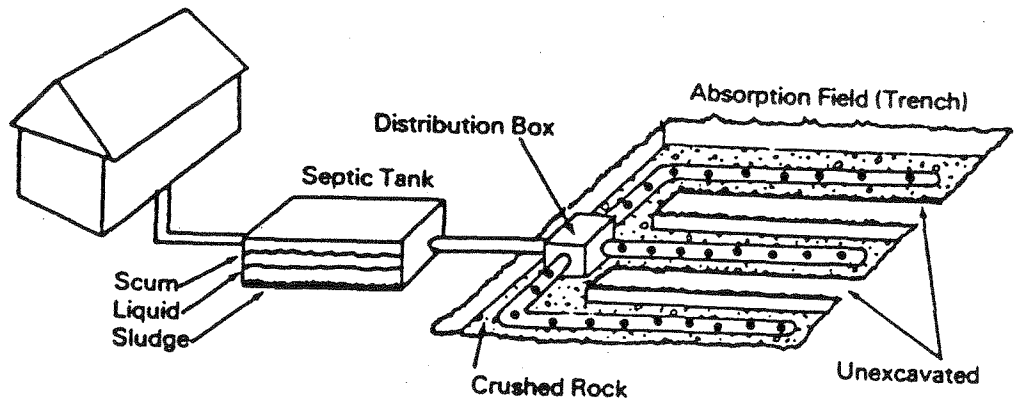

An individual sewage treatment system consists of two parts: (1) the sewage tank; and (2) the soil treatment system (sometimes called a “drainfield” or “leach bed”). Both serve important wastewater treatment functions.

### Sewage Tanks

There are two types of sewage treatment tanks -- a septic tank and an aerobic tank. Septic tanks are more common.

A septic tank slows the flow of liquid from the house or building and allows the solids to separate from the wastewater. In a properly functioning septic tank, there will be three distinct layers. The top layer is called scum and consists of those particles which are lighter than water. These include lint, grease and soap scum. The bottom layer

is called sludge and consists of those solids that sink during the settling process because they are heavier than water. The middle layer, called septic tank effluent, is a relatively clear liquid which is discharged to the soil treatment system. Septic tank effluent contains fine suspended solids, many disease-causing bacteria and nutrients. It cannot be disposed of on the ground surface or in surface waters without causing potential health problems, nuisance conditions or eutrophication. It must be treated in a soil treatment system.

Aerobic tanks are not used as often as septic tanks due to higher capital and operation/maintenance cost. There is no reduction in the size of a soil treatment area for an aerobic tank system. Aerobic tanks require an energy source to maintain free oxygen in the system. The wastewater is aerated similar to an activated sludge treatment process. Decomposed solids settle and the effluent is then discharged to the soil treatment system.

Decomposition of solids takes place in both types of tanks. If it were not for decomposition, the tank would quickly fill with solids and become ineffective. In a septic tank, anaerobic bacteria break down coarse solids into finer solids and dissolved substances. Aerobic bacteria break down solids in an aerobic tank. These substances are carried in the septic tank effluent to the soil treatment system.

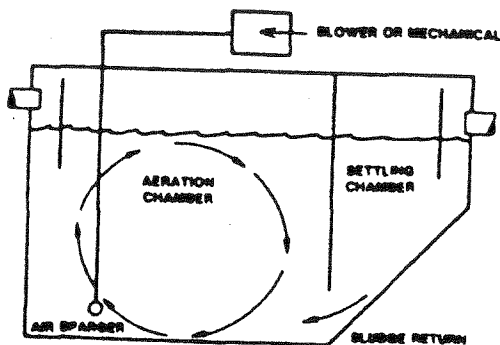

A sewage tank must be large enough to allow the incoming sewage to settle, to allow for decomposition of settled solids and to store both settled and floating solids. Adequate size and baffle construction are important features of a septic tank since the main purpose of a septic tank is to remove solids and protect the soil treatment system. The



best design maximizes liquid surface area while maintaining adequate depth to allow for storage of accumulated solids for two to three years.

### Soil Treatment Systems

The soil treatment system is the heart of the sewage treatment system since this is where most of the treatment occurs. Unsaturated flow should be established in a soil treatment system. This occurs naturally in an efficient system. Perforated distribution pipes carry the effluent to a trench or bed. The trenches have been carefully constructed to maximize the surface area where the effluent meets the soil. Several inches of crushed rock support the distribution pipes and allow the water to flow freely from the pipes to the soil.

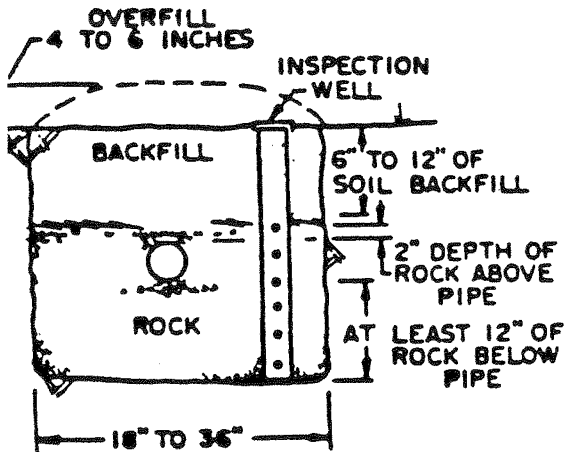

A biomat forms at the interface where the trench rock meets the soil. This is at the base or bottom and sidewalls of the soil treatment system. The biomat is a layer of fine solids and micro-organisms. The organisms are connected to one another by a glue-like substance which they secrete. The biomat is approximately one inch thick and has a black jelly-like appearance.

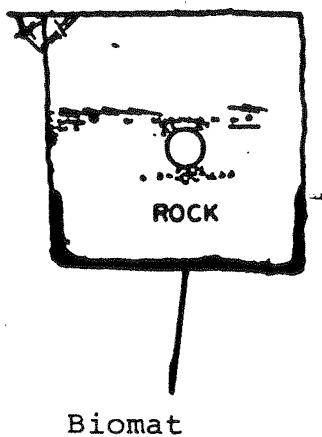

In an efficient system, there will be some effluent ponded in the trench. The main job of the biomat is to act as a "valve" to slow down the flow of ponded wastewater into the soil. The large pores drain and fill with air on the soil side of the biomat. The septic tank effluent flows through the smaller pores. Aerobic bacteria use the oxygen contained in the large pores to decompose the waste.

The biomat should reach an equilibrium and stay at about the same thickness. It should also allow the same amount of wastewater through on a continuing basis. The biomat will build up from the increase in number of anaerobic organisms and from the build-up of fine solids. When this happens, it is broken down on the outside by aerobic and facultative bacteria living in the soil. The biomat's thickness and permeability will be consistent as long as the system is properly maintained.

The biomat provides excellent treatment. Three feet below the bottom of the soil treatment system all suspended solids, oxygen demanding particles, and pathogens have been removed. The suspended solids are removed by filtration and by micro-organisms in the soil.

#### Operation and Maintenance

The septic tank must be periodically pumped to remove accumulated sludge and scum. Pumping frequency is about every one to three years for a 1,000-gallon tank serving a three-bedroom, four occupant home. The tank must be inspected for leaks and baffle condition after pumping.

Excess water should not enter the tank. Be conservative with water use. Each gallon of water used must be treated and disposed. Repair all leaky fixtures and reduce the amount of water used by laundry, bathing and toilets.

Wash only full loads of dishes and clothes. Schedule laundry throughout the week to avoid overloading the system in a single day.

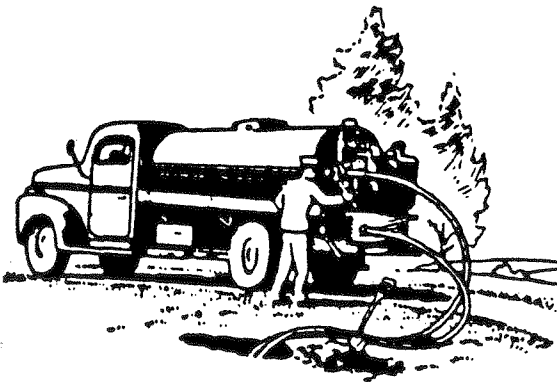

#### **Conserve Water**

Each bath or shower uses up to 30 gallons of water. Water consumption can be reduced by five to ten gallons per shower or bath by using reduced-flow shower heads and less water for bathing

Routinely check the toilet float valve to be sure that it is not stuck open. Do not flush the toilet unnecessarily. The last person washing up in the morning and evening could flush the toilet after everyone else has used it. This can save 20 to 30 gallons a day for a family of four.

Foundation drains, roof leaders, and sump pumps should not be connected to the sewage treatment system. Divert drainage away from the septic tank and drainfield because the excess water can cause failure.

If a garbage disposal is used, the solids may need to be removed every year. Ground garbage will frequently pass through the septic tank and clog the soil treatment system. It is better to compost or throw out garbage with the trash.

## **Keep Out**

Do not deposit coffee grounds, cooking fats, wet-strength towels, disposal diapers, facial tissues, cigarette butts and similar nondecomposable materials in the septic tank. Avoid dumping grease down the drain. Grease can build up and plug the tank inlet. Keep a separate container for waste grease and throw it out with the trash.

Use a toilet tissue that breaks up easily when wet.

Normal amounts of detergent, bleach, drain cleaners, toilet bowl deodorizers and other household chemicals can be used without harming the bacterial action in the septic tank. Some of these products contain volatile organic substances which may cause ground water contamination.

## Additives

A “starter” is not needed for bacterial action to begin. All necessary bacteria are already present.

Additives should not be used because they are not beneficial. The additives may do great harm if they cause the sludge and sum to be flushed out into the soil treatment area.

Degreasing additives may be carcinogenic (cancer-causing) and can flow directly into the ground water.

Water softener backwash will not harm septic tank action but the additional water will need to be considered when designing the soil treatment system.

Vehicles should be kept off the soil treatment system, especially in winter, to prevent driving down the frost which blocks the soil treatment system.

## Resting

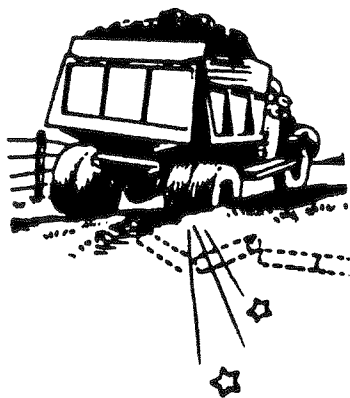

With some soil types, the best maintenance for the soil treatment system may be to rest a portion of the system for a year. Resting allows the biomat to dry up and oxidize as air enters the soil. This will restore the original soil filtration capacity.

Inspection wells at the end of each trench allow monitoring of the liquid level. If a problem occurs, the inspection wells offer an easy access point to monitor the trench. This may save a homeowner time and money in diagnosing the problem.

Installing a water meter can also aid in diagnosing a problem. Periodic flow measurements give the homeowner a good estimate of the amount of wastewater the family generates.

## SLOW-RATE SYSTEMS

### Introduction

Types of slow-rate systems are surface application of wastewater using spray irrigation or ridge and furrow techniques. Establishing and maintaining vegetation are critical if water and nutrients are to be managed. If properly located, designed and operated, these systems can produce an effluent that contains the following average concentrations (mg/l) of contaminants: BOD, < 2; suspended solids, < 1; ammonia nitrogen, < 0.05; total nitrogen, 3; total phosphorus, < 0.1; and 0 fecal coliform.

The system size and application rate vary with the quantity and characteristics of wastewater, soil and crop type, slope of land and climate. Systems should be large enough to provide flexibility in operations and to accommodate crop removal and replanting if necessary.

### Operation/Maintenance

Several types of systems are used to distribute wastewater onto a land treatment system. They include ridge and furrow, moveable and fixed set, traveling gun and center pivot sprinklers. The complexity of operation and the labor needed to work each system varies.

Moveable and fixed set systems are a series of above or below ground pipes with risers that connect to the sprinkler heads. Each lateral and riser should have a control valve which can stop/start their portion of the system.

A traveling gun is a wheel mounted sprinkler which moves by water pressure. This pressure is created by pumping water through the system. The traveling speed and area covered can be adjusted.

### **Spray Irrigation**

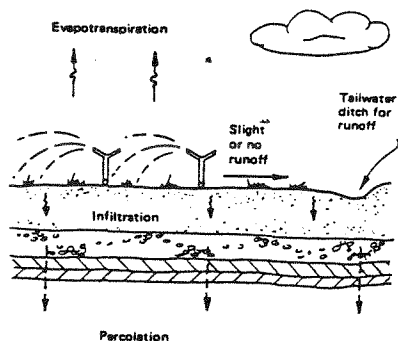

### **Ridge and Furrow**

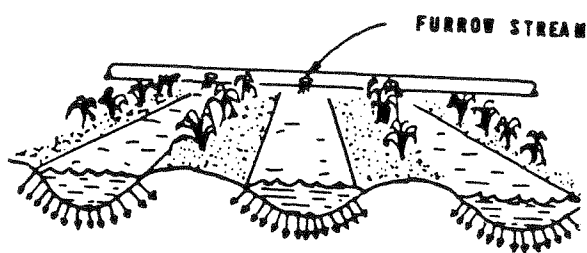

### **Set Systems**

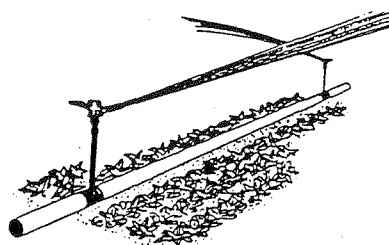

### **Big Gun**

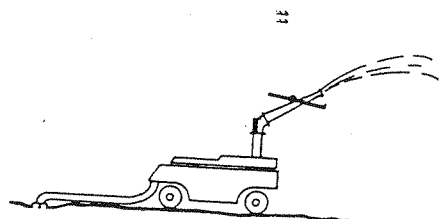

## Center Pivot

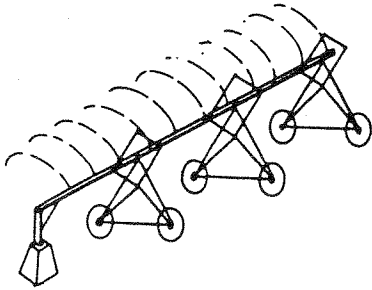

A center pivot irrigation system revolves partially or entirely around a fixed inlet point. Electric motors turn the wheels at varying speeds to keep the system in alignment. Sprinkler heads should be equipped with individual shut-off valves. The application rate is regulated by adjusting the flow and the sprinkler rate of speed.

A routine maintenance schedule on pumps, pipes, moveable parts and preliminary treatment units is necessary to assure continual system operation.

Operators should have farming/crop production experience. The decisions that an operator must make include: 1) how much water to apply; 2) how frequently to apply it; and 3) where it should be applied.

The quantity to apply will depend on the amount of moisture in the soil. Application must be controlled to prevent runoff and to prevent soil saturation yet provide enough moisture for the crop. The soil must remain aerobic and unsaturated if treatment is to occur. The gallons per acre or "acre inches" of water to apply can be determined based on soil moisture content. The application equipment should be adjusted to assure that all parts of the field receive the appropriate amount of water. Since a field may have different types of soil, the application rate may vary. The operator must be careful to prevent compacting or rutting of the soil which can be caused by the use of field application equipment.

## Frequency

Application frequency is determined by soil moisture content, by crop usage of water and by the loss of moisture through evaporation and percolation.

Vegetation is a main part of the treatment system. It is essential to maintain a suitable cover crop. The crop uses nutrients and protects the soil from erosion.

## Sampling

Periodic sampling of the soil, wastewater, and, in some cases, ground water, crop tissue and surface water is important. Sampling is done to monitor the system efficiency and to adjust practices for the reduction of environmental impacts.

## RAPID-RATE SYSTEMS

### Introduction

A rapid-rate infiltration system is a series of ponds/beds which are designed to leak and recharge ground water. The system is operated by flooding a bed and allowing it to drain - then reflooding at a later date. Vegetation is not important. A properly designed and operated system can produce an effluent that contains the following average concentrations (mg/l) of contaminants: BOD, 5; suspended solids, 2; ammonia nitrogen, 0.5; total nitrogen, 10; total phosphorus, 1; and 10 fecal coliform per 100 ml.

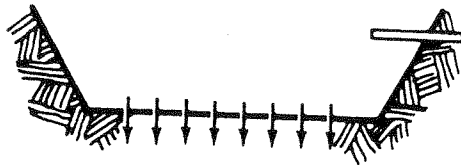

Rapid Infiltration Basins

Rapid Infiltration Basins

### Operation/Maintenance

Wastewater that has received primary or secondary treatment is pumped into basins. The basins are allowed to drain and dry before adding more water. The operator must decide the schedule for pumping/flooding.

In addition to routine pump/pipe maintenance, the beds will require some periodic maintenance. This involves either removal of accumulated solids or surface scarification/

discing to break up the solids. This is done to restore the bed to its designed infiltration rate.

Routine monitoring of ground or surface water is also necessary.

## OVERLAND FLOW SYSTEMS

### Introduction

Overland flow systems are similar to slow rate systems. Wastewater is applied on sloping ground and allowed to flow through vegetation to a collection ditch or pond. From there it may be reapplied or discharged to a surface water. Ground water recharge is not a significant part of the system design since the soil normally has a slow permeability. Experience has shown that this land treatment system is the least effective in removing contaminants. Average concentrations (mg/l) of effluent wastewater are as follows: BOD, 10; suspended solids, 10; ammonia nitrogen, < 4; total nitrogen, 5; total phosphorus, 4; and 200 fecal coliform per 100 ml.

### Operation/Maintenance

The same operation and maintenance schedules and procedures are needed as with slow rate systems. Vegetation maintenance and control of soil erosion is extremely important to assure system reliability. Vegetation (cover crop) may be mowed but should not be removed. The accumulated thatch is necessary for the development of a slime layer similar to that developed on trickling filter media.



## REFERENCES

1. Home Sewage Treatment Workshop Workbook, Agricultural Extension Service, University of Minnesota and Minnesota Pollution Control Agency.
2. Town and Country Sewage Treatment, Bulletin 304, Agricultural Extension Service, University of Minnesota.
3. Get to Know Your Septic Tank, Folder 337, Agricultural Extension Service, University of Minnesota.
4. Design Process Manual, Land Treatment of Municipal Wastewater, U.S. Environmental Protection Agency. 625/1-81-013.
5. Operation and Maintenance Considerations for Land Treatment Systems, U.S. Environmental Protection Agency. 600/2-82-039.
6. Land Application of Sludge, Operations Training Unit, Minnesota Pollution Control Agency.

# DISINFECTION

## TABLE OF CONTENTS

	<u>PAGES</u>
<u>INTRODUCTION</u>	168
<u>THEORY</u>	168
<u>OPERATION</u>	169
<u>DESIGN</u>	171
<u>MAINTENANCE</u>	173
<u>SAFETY</u>	174
<u>DECHLORINATION</u>	176
<u>SUMMARY</u>	177
<u>REFERENCES</u>	178

## INTRODUCTION

Wastewater contains bacteria from both healthy and sick people who discharge their wastes into a collection system. Although the settling and biological processes in primary and secondary treatment units remove many of these organisms from the wastewater, there are still a large number of bacteria and viruses in the effluent from these processes. Some of these organisms are pathogenic (disease producing) and must be eliminated before being discharged to a receiving stream. Disinfection is used to kill these remaining pathogenic organisms. Disinfection is considered a part of the secondary treatment process.

## THEORY

It should be noted that a difference exists between disinfection and sterilization. During disinfection, most but not all, pathogens in the wastewater are destroyed. A few of them may still remain in the wastewater effluent. However, dilution in a receiving stream reduces the risks presented by these few remaining pathogens. Sterilization is different in that it kills all organisms present in the wastewater. Since treatment facility effluents contain some living organisms, even after disinfection, it is not considered sterile.

Since there can be many different types of pathogenic micro-organisms in wastewater, the cost of testing for all of them would be prohibitive. Therefore, a single type of micro-organism, fecal coliform bacteria, are used as an indicator for the presence of pathogens. Although fecal

**DISINFECTION: The significant reduction of pathogenic (disease producing) micro-organisms**

**PATHOGENS/  
PATHOGENIC  
MICRO-ORGANISMS:  
Bacteria or virus  
which can cause diseases**

**FECAL COLIFORM  
BACTERIA:  
Indicators of pollution**

coliform bacteria are not pathogenic, their presence indicates that pathogens may be present.

Treatment plant effluent can be disinfected in a number of different ways. Any process which creates an unfavorable environment for the organisms will serve as a disinfectant. Strong light can be used for this purpose as well as heat, oxidizing chemicals, acids, alkalies or bases and poisons.

## CHLORINATION

Chlorination is the major means of disinfection in use today. Chlorine may be added to wastewater as a gas dissolved in water or in the form of a hypochlorite obtained from salts such as sodium or calcium hypochlorite. A sufficient amount of chlorine (in whatever form) must be added to kill the bacteria and viruses.

Chlorine added to wastewater causes two reactions - a chemical reaction with chemicals in the wastewater, and a disinfecting reaction with bacteria and other organisms. The chemical reactions occur quickly while the disinfection reactions occur more slowly. Approximately 15 to 30 minutes contact time between the chlorine and wastewater is needed for the chlorine to react with these chemicals and eventually kill most of the pathogens.

## OPERATION

### **CHLORINE DOSAGE:**

**Chlorine added**

The amount of chlorine added to wastewater is called the chlorine dosage. The amount of chlorine which reacts with chemicals, organic matter, viruses and bacteria in the wastewater, is termed the chlorine demand. The more chemicals and organic matter the wastewater contains, the greater the chlorine demand is. Chlorine residual is the

### **CHLORINE DEMAND:**

**Chlorine used**

**CHLORINE RESIDUAL:**

**Chlorine remaining**

amount of chlorine remaining in the wastewater after the chlorination process.

Chlorine demand is calculated by finding the difference between the amount of chlorine added to the wastewater (chlorine dosage) and the amount of residual chlorine remaining at the end of a specified contact period.

$$\text{CHLORINE DEMAND} = \text{CHLORINE DOSAGE} - \text{CHLORINE RESIDUAL}$$

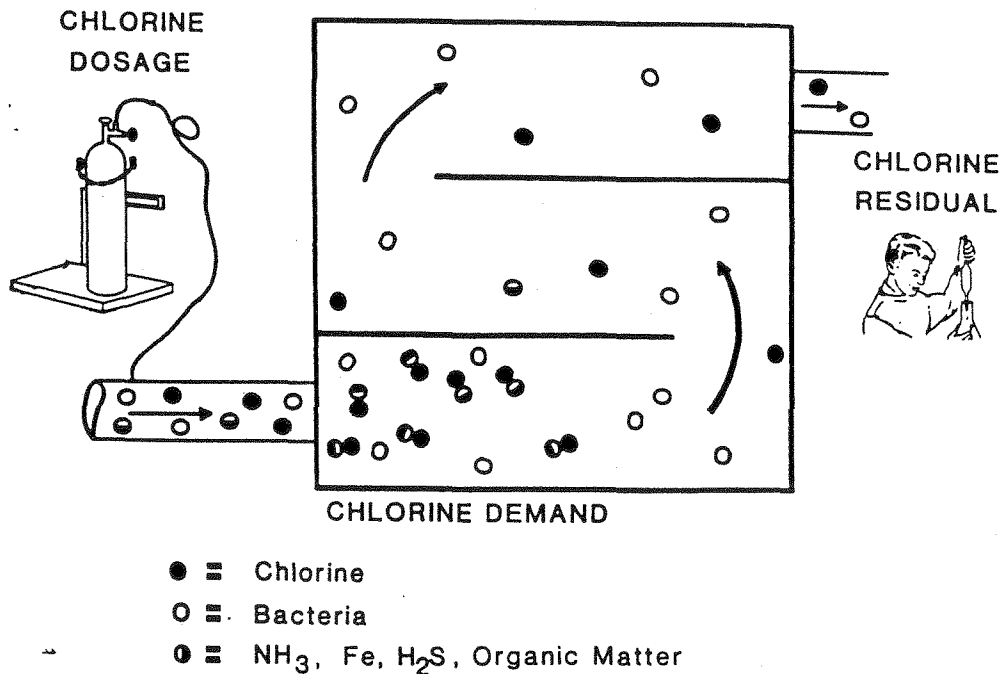

Usually chlorine dosage is determined by looking at the process from the back end. Start by determining the lowest level of chlorine residual possible which will still allow you to meet your NPDES permit limits for fecal coliform. As a general guide to follow, maintain a residual of 0.5 milligrams per liter (mg/l) after 30 minutes contact time at average flow. If the chlorine residual can be lowered even more and still meet standards, the dosage should be reduced.

Your NPDES permit should be checked to determine the fecal coliform limits which apply to your facility. A chlorine residual which is too high may cause damage to life in the receiving waters due to the toxicity of chlorine. On the other hand, if too little chlorine is added to the wastewater, all of the pathogens will not be killed. In either case, problems can occur for people who use the receiving waters for fishing and recreational purposes. A proper balance must be maintained between chlorine dosage and chlorine residual to insure maximum disinfection while minimizing the harmful effects of chlorine residual. The chlorine residual and fecal coliform tests are two ways of monitoring this balance.

#### DESIGN

There are two common types of equipment for application or injection of chlorine:

- 1) Solution Feed Gas Chlorinators - A chlorinator which mixes chlorine gas with an auxiliary supply of water and applies it to the wastewater. This is the most common method and is generally preferred for all but extremely small facilities.
- 2) Hypochlorinators - A chlorinator which pumps a liquid chlorine solution (mixed by the operator) to the waste stream. The hypochlorinator may be driven by electricity, gravity or displacement. Hypochlorinators are generally used for low flows or emergency use.

A few facilities may still use dry (direct) feed gas chlorinators which introduce dry chlorine gas directly into wastewater. However, these should be used only when pressurized water is not available and they are not recommended due to potential safety problems.

Types of controls for chlorinators include manual, semi-automatic and fully-automatic. The rate of chlorine feed on a manual control is varied by hand. A semi-automatic feed starts and stops automatically by electric or hydraulic means, turning on only when the wastewater pump turns on. With a fully-automatic control, the feed rate is controlled automatically by means of a flow meter or chlorine residual analyzer.

Two essential elements - mixing and contact time are needed to insure the most effective disinfection.

The chlorine must be added in an area where it is mixed with the wastewater as rapidly as possible, with complete mixing occurring within three seconds. This may be accomplished by use of a mechanical flash mixer or some device to create an extremely turbulent flow.

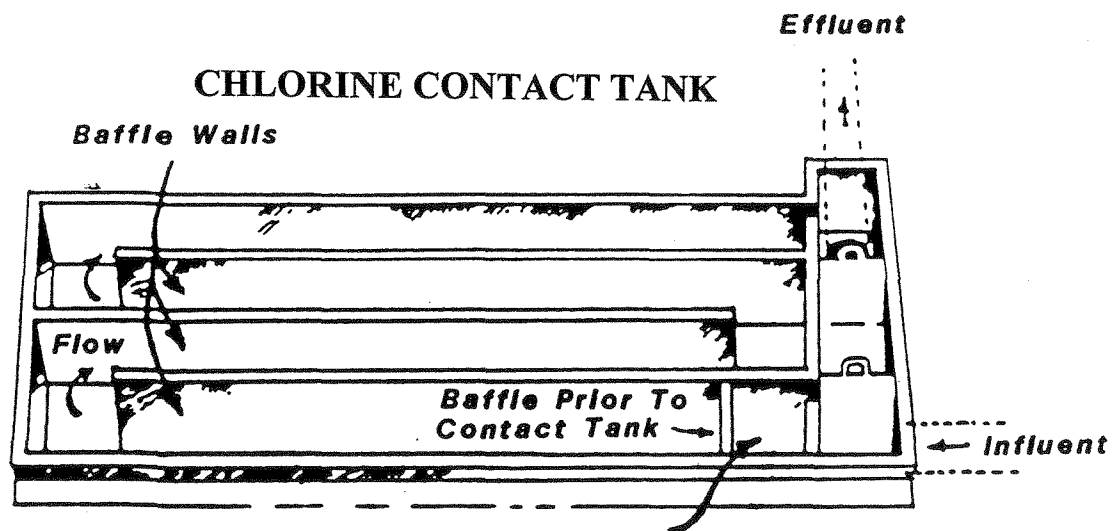

**Chamber For Chlorine Application And Rapid Mixing Device**

To get a maximum kill of pathogens, the chlorine must come in contact with them for a minimum of 15 minutes at the peak hourly flow rate or maximum pumping rate. Baffles should be added to the contact tank to assure adequate detention time and minimal short-circuiting.

### MAINTENANCE

Maintenance of a disinfection unit is important not only to prevent breakdowns, but for safety purposes because of the toxicity of chlorine gas.

#### **Chain the Cylinders**

Chlorine cylinders should be chained to a wall to prevent them from tipping over. The protection hood should always be in place on top of cylinders not in use. When changing chlorine cylinders, all pipe fittings must be kept tight to avoid leaks. New gaskets should be used for each new connection.

#### **Keep Equipment Dry**

Chlorinator parts which will come in contact with chlorine gas must be kept dry. Chlorine which comes in contact with moisture, even moisture in the form of humidity in the air, will form hydrochloric acid. Any parts of a chlorinator which are cleaned with water must be thoroughly dried with wood alcohol, followed by drying or by using a heater to remove all traces of moisture.

#### **Water Strainers**

Water strainers or chlorinators frequently clog and require attention. they may be flushed with water, or if really fouled, may be cleaned with dilute hydrochloric acid followed by a water rinse.

#### **Vent Lines**

The vent lines from chlorinators must be kept open. These vent lines evacuate the chlorine to the outside when



the chlorinator is being shut down. A screen should be placed over the end of the vent line to prevent insects from entering and plugging it.

When chlorinators are removed from service, as much chlorine gas as possible should be removed from the supply lines and machines. The chlorine injector should be run for a period of time with the chlorine valves closed at the cylinders to remove the chlorine gas.

### **Remove Sludge From the Chlorine Contact Tank**

Sludge which accumulates in the bottom of the chlorine contact tank should be periodically removed. Sludge in the tank will react with the chlorine being added. This reduces the efficiency and extra chlorine must be added to compensate. Sludge should not be allowed to accumulate more than a few inches deep.

### **SAFETY**

Chlorine is a deadly poisonous gas which can kill a person in seconds. Therefore, extreme caution and safety procedures must be added when handling it.

In an emergency, only authorized persons with proper safety equipment should be in the danger area. The local fire department should examine chlorine handling facilities and safety equipment. When chlorine gas combines with any moisture, it becomes highly corrosive as well as toxic. Therefore, a chlorine leak becomes worse in a moist atmosphere. Do not spray water on a leaking chlorine cylinder or use it to check for a leak. When a leak is suspected, an ammonia-moistened cloth should be held near the suspected area. If chlorine is escaping, a white cloud will form.

Serious damage may result to anyone breathing chlorine-contaminated air. Concentrations of chlorine gas in excess of 1,000 mg/l may be fatal after a few breaths. This is equivalent to approximately one cubic foot of chlorine gas (five liquid ounces) released in a normal sized chlorine room. Chlorine leaks and releases from the lines are probably most common when a cylinder is being changed. Changing cylinders is one of the most dangerous times for an operator and extra safety precautions should be taken.

**WARNING**

WHEN ENTERING A ROOM THAT MAY CONTAIN CHLORINE GAS, OPEN THE DOOR SLIGHTLY AND CHECK FOR THE SMELL OF CHLORINE. **NEVER** GO INTO A ROOM CONTAINING CHLORINE GAS WITH HARMFUL CONCENTRATIONS IN THE AIR WITHOUT A SELF-CONTAINED AIR SUPPLY, PROTECTIVE CLOTHING AND HELP STANDING BY. HELP MAY BE OBTAINED FROM YOUR CHLORINE SUPPLIER AND YOUR LOCAL FIRE DEPARTMENT.

Chlorine is 2.5 times heavier than air and will collect in low areas. This means that extreme caution must be practices when entering low areas.

Ventilation is required for all chlorine equipment rooms. The ventilation intake of the exhaust fan must be located at the floor level. A self-contained air supply should be located outside of the chlorine storage area and is essential when high concentrations (above 1 percent by

volume with air) could be present. Canister type gas masks are inadequate in situations where chlorine leaks occur and are not recommended for use under any circumstances.

**WARNING**

CANISTER TYPE "GAS MASKS" ARE USUALLY INADEQUATE AND INEFFECTIVE WHERE CHLORINE LEAKS OCCUR AND ARE THEREFORE NOT RECOMMENDED FOR USE UNDER ANY CIRCUMSTANCES. SELF-CONTAINED AIR OR OXYGEN SUPPLY TYPE BREATHING APPARATUS ARE RECOMMENDED.

### DECHLORINATION

Dechlorination is the removal of any amount of residual chlorine remaining after disinfection. Various studies have shown the need for protection of the receiving waters from toxic substances, such as chlorine. Consequently, regulations now require effluent limits on chlorine residual; some as low as 0.038 mg/L.

Dechlorination can be accomplished by the following:

- 1) Long detention time;
- 2) Aeration;
- 3) Sunlight;
- 4) Activated Carbon; and
- 5) Chemical reaction.

Of those mentioned, chemical reaction is the one most often used. Typical chemicals used are sulfur dioxide, sodium sulfite, sodium bisulfite, sodium metabisulfite, and sodium thiosulfate. Of these, sodium dioxide is the most

popular. It reacts instantaneously with chlorine on approximately a one-to-one basis (one part of sodium dioxide to one part of chlorine residual).

### SUMMARY

Chlorine, or some other disinfectant, is usually added to the secondary effluent. Disinfection kills off pathogens as well as other organisms in the wastewater. Although it is extremely difficult to kill off all pathogens, disinfection significantly reduces the number of them and other organisms being passed to the effluent. If done properly, disinfection kills more than 99 percent of the harmful pathogens in an effluent.

Dechlorination is the removal of any remaining chlorine residual in the effluent. Typically, sodium dioxide is the most often used chemical to accomplish this.

## REFERENCES

1. Chlorination of Sewage & Industrial Wastes, Manual of Practice No. 4, Water Pollution Control Federation.
2. Operation of Wastewater Treatment Plants, Manual of Practice No. 11, Water Pollution Control Federation.
3. Manual of Instruction for Wastewater Treatment Plant Operators, Vol. I, New York State Department of Environmental Conservation.
4. Operation of Wastewater Treatment Plants, Vol. 1, University of California, Sacramento.

# SOLIDS HANDLING

## TABLE OF CONTENTS

	<u>PAGES</u>
<u>INTRODUCTION</u>	180
<u>SLUDGE THICKENING</u>	180
<u>DIGESTION</u>	182
Introduction	
<u>AEROBIC DIGESTION</u>	183
Theory and Design	
Operation and Maintenance	
<u>ANAEROBIC DIGESTION</u>	186
Theory and Design	
Operation and Maintenance	
<u>BIOSOLIDS CONDITIONING</u>	191
<u>BIOSOLIDS DEWATERING</u>	192
<u>STORAGE</u>	195
<u>BIOSOLIDS OPTIONS FOR UTILIZATION OR DISPOSAL</u>	196
Land Application	
Incineration	
Landfilling	
<u>REFERENCES</u>	197

## INTRODUCTION

The various processes which are used to treat wastewater and consequently make the water cleaner, leave a solids by-product. This by-product known as sludge, the solids removed during wastewater treatment, must be properly treated and disposed of in order to protect all areas of the environment. This chapter will go through sludge treatment and disposal processes including thickening, digestion, conditioning, dewatering, incineration, storage, composting and land application.

## SLUDGE THICKENING

Sludge thickening is the concentration of suspended solids to produce a sludge which can be digested more economically and in smaller tanks.

Gravity thickening works on the same principle as a clarifier. The solids settle in the bottom of a basin due to gravitational force. The solids are then scraped, by a raking mechanism, into a well and are drawn from the bottom for additional processing. Stirring devices located on the raking mechanism help to release bound water from the mass and compact the sludge solids. The supernatant flows over the weirs and is generally returned to primary or secondary treatment units. This is a common form of thickening because it is relatively inexpensive and easy to operate. One drawback to this process is that the resulting sludge is not as concentrated in comparison to other methods of thickening.

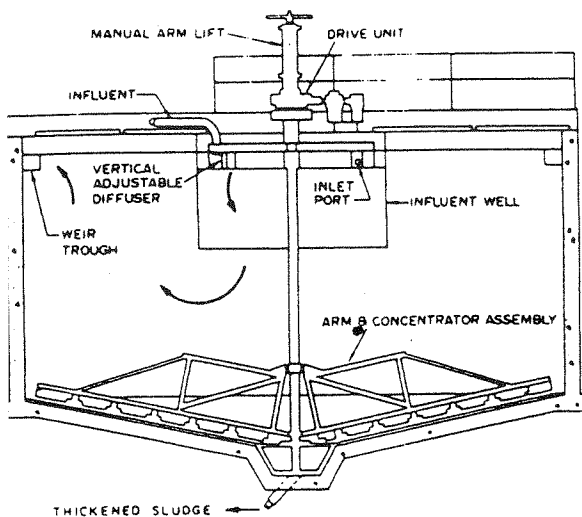

**Gravity Thickener**

## **Air Flotation Thickener**

Dissolved Air Flotation or DAF is used primarily for thickening light sludges. The addition of air allows the solid particles to be separated from the liquid. Bubbles attach to the solids particles and increase their buoyancy. The particles float and are skimmed from the surface of the unit. Thickening occurs in the floating sludge blanket which can range from 8 to 24 inches thick. Flocculating chemicals are sometimes added to the DAF unit in order to increase the efficiency of solids removal.

The dissolved air flotation method is a common way of thickening waste-activated sludge solids. This is due to the high efficiency rate of solids removal in a relatively short time. Detention times are not critical after a minimum of one and one-half to three hours.

The percentage of solids in the effluent sludge will vary depending on many variables such as solids and hydraulic loading rates, type of feed sludge, etc.

Sludge thickening by use of centrifugal force (or centrifugation) is similar to dewatering by the same method. A cylindrical drum or bowl rotates at a high speed in order to separate the sludge solids and liquid. The higher density of the solids creates a separation into two distinct layers -- a solids layer and a liquid layer. These layers are then removed from the unit separately and are discharged.

Basket, disc-nozzle and solid bowl centrifuge units have been used for both thickening and dewatering.

As the slurry is fed into a basket centrifuge, solids form a cake on the unit walls while the liquid is discharged over the weirs. The unit stops when the sludge build-up reaches a



maximum level and a scraper removes the sludge cake. Basket centrifuges are used mainly for smaller facilities. Only small volumes of sludge can be thickened due to the interruption of operation needed to remove the solids build-up.

This method has the capability to produce the driest sludge of the three centrifuge units.

The disc-nozzle centrifuge works basically on the same principle as the basket centrifuge. In contrast, the disc-nozzle uses continuous operation, whereas the basket centrifuge uses batch-type thickening. The final solids concentration is limited due to small openings in the sludge cake discharge area.

The solid-bowl centrifuge is used mostly for dewatering rather than thickening, so its use is described in the dewatering section.

Centrifuges in general are used more for dewatering than thickening. If they are going to be used for thickening, their use is limited to thinner, biological or industrial sludges which cannot be thickened less expensively. Their operating performance depends on many variables such as influent sludge type and feed rate, bowl design and speed, chemical addition, etc.

## DIGESTION

### Introduction

In most wastewater treatment plants, the sludge from primary and secondary units is digested. Digestion produces a sludge which is easier to handle, has less water and creates fewer nuisance conditions. During digestion, additional

### **WHY DIGEST?**

**Less Sludge**

**Less Water**

**Reduce Pathogens**

**Stabilize Sludge**

organic matter is broken down to eliminate odors. Water bound up in the sludge is released and pathogens are greatly reduced.

There are two types of digesters: aerobic and anaerobic. Aerobic digesters use aerobic micro-organisms to stabilize the sludge. They are usually used at small activated sludge plants and work well on this type of sludge. Advantages of aerobic digesters are that they are relatively simple to operate, cost less to construct (mainly because the air supply equipment is already present for the activated sludge process) and return a supernatant which is easy to treat. A disadvantage of the aerobic digester is its high operational costs because of high energy use.

Anaerobic digestion, on the other hand, employs anaerobic and facultative bacteria to stabilize the sludge. In addition to an odorless, low pathogen sludge, methane gas is generated which can be used to heat buildings and/or produce electricity. Advantages of anaerobic digestion are its ability to handle both primary and thickened secondary sludges, low energy consumption, and the production of a useful gas - methane. Disadvantages include more difficult operation and maintenance, longer startup and subjectivity to shock loads and overloads.

## AEROBIC DIGESTION

### Theory and Design

Aerobic digesters operate similarly to activated sludge plants. Micro-organisms suspended throughout the liquid eat the food (i.e., organic matter in the sludge pumped to it) and use oxygen supplied by mechanical aerators or diffusers.

The major difference between aerobic digesters and activated sludge is that the detention time in an aerobic digester is 10-60 days compared to 2-20 hours in activated sludge. There are two products of aerobic digestion: stable sludge and a clear supernatant. Occasionally a scum layer develops, but this can be removed by either manual or mechanical skimming.

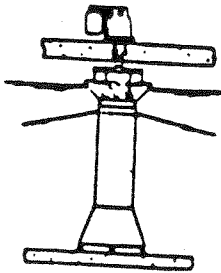

**Mechanical**

The oxygen needs for aerobic digestion are supplied by either mechanical aerators, coarse bubble diffusion or fine bubble diffusion.

Mechanical aerators have been widely used in small uncovered digesters where freezing is not a serious operational problem. Covers are desirable in cold climates to reduce heat loss and minimize the freezing potential.

**Coarse Bubble Diffusers**

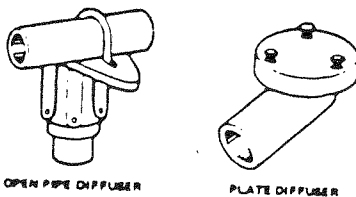

**Fine Bubble Diffusers**

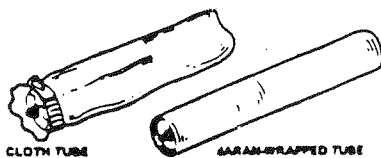

Coarse and fine bubble diffusers are often used with rotary or positive displacement air blowers. Larger digesters may use centrifugal blowers as the source of compressed air.

Operation and Maintenance

Operation of an aerobic digester is very similar to the operation of an activated sludge plant. The major difference is that the solids concentration in an aerobic digester is much higher than in an aeration basin. There is also less concern about proper settling in an aerobic digester.

There are certain factors which an operator must control to obtain effluent aerobic digestion:

Food is normally supplied by waste sludge. Waste sludge can come from a clarifier or from an aeration tank.

When loading (feeding) a digester, it is best to concentrate the sludge as much as possible and feed it continuously or frequently in small amounts.

The purpose of mixing is to provide contact between the micro-organisms and the waste sludge. Mixing should be continuous, but not violent.

An operator should try to keep the dissolved oxygen (DO) in the range of 0.5 to 2.0 milligrams per liter (mg/l) at all times.

Two products of aerobic digestion tend to lower the digester pH -- carbon dioxide and nitrification. Because of this tendency, digester pH can range anywhere from 5.9 to 7.7. The best pH is as close to seven as possible.

Chemicals such as oils, solvents and other toxic materials may be harmful to the micro-organisms and should not be sent to the digester.

When the temperature of the digester drops below 15C (59°F), the microbial activity is severely reduced and longer detention times are needed for digestion. If the temperature gets much below 15°C, consideration should be given to covering the digester.

One of the easier tests an operator can do to ensure proper digestion is to let one (1) liter of digested sludge stand idle in a beaker in the laboratory. After 24-36 hours, the sludge should be visually inspected for black, anaerobically digested areas, and gently stirred to detect any putrid odor. If black sludge does develop and putrid odors are noticeable, the sludge has not been adequately digested. In this case, an operator should provide additional detention time for adequate digestion before sludge removal.

Some other control tests are dissolved oxygen (DO), pH and total suspended solids. Dissolved oxygen should be measured daily and maintained in the range of 0.5 to 2.0 mg/l. The pH should also be measured daily and not allowed to drop below 5.0. Suspended solids in a digester will vary from plant to plant. Operators can determine at what level their plant will run best. This test should be performed at least once a week, or prior to removal of sludge.

## ANAEROBIC DIGESTION

### Theory and Design

Anaerobic digestion is the opposite of aerobic digestion. Instead of bubbling air through the sludge, air must not be present. Decomposition of organic matter in an anaerobic digester is a two-step process involving two different types of anaerobic bacteria. During the first step, organic matter is converted to organic acids by acid-forming bacteria. During the second step these organic acids are used as food by the methane-producing bacteria which convert them into methane (CH<sub>4</sub>) and carbon dioxide (CO<sub>2</sub>) gases. It is during this last step that bound water is released and sludge is stabilized.

Stable sludge, gas (methane and CO<sub>2</sub>), supernatant and scum are four products formed during anaerobic digestion. Since an anaerobic digester is sealed to prevent oxygen from entering, it is difficult to remove the scum. For this reason, the oils, greases and fats which form the scum layer should not be sent to an anaerobic digester.

## **DIAGRAM OF WASTE STABILIZATION**

Anaerobic digester detention time is usually from 15-30 days longer. Since the methane-producing bacteria function

in the narrow temperature range of 85° - 100°F, anaerobic digesters are almost always heated.

## Equipment

The type of digester will affect what an operator can or cannot do to control the digestion process. Scum formations, supernatant clarity and layering are affected by the type of anaerobic digester and other related equipment used.

In unheated and unmixed digesters, the sludge arranges itself in layers. If allowed to build up over a period of years, scum layers and grit deposits will seriously reduce the detention time of the digester, making it difficult to obtain a well-digested sludge.

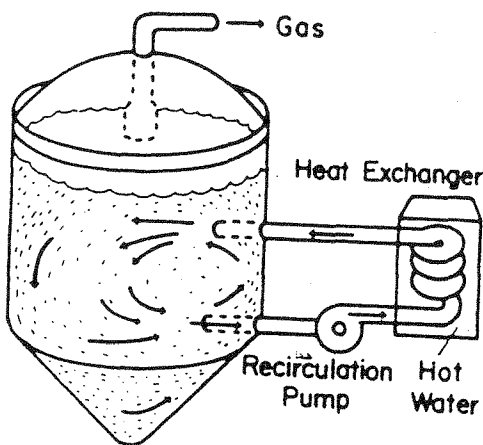

**SINGLE COVERED  
DIGESTER WITH  
RECIRCULATION**

Covered digesters use covers to collect gas, a recirculation pump or gas and mechanical mixers for mixing and a heat exchanger for temperature control. Recirculation provides a mixing action which will enable the bacteria to have more contact with the food and a means of controlling the temperature by pumping it through a heat exchanger. The cover collects methane gas for use in the plant, providing a means of recovering some of the costs of digestion.

A two-stage system has the advantage of using one tank (the primary) for active mixing and digestion, and the second tank for settling. The second tank also contains a large volume of active bacteria which can be used as seed sludge if the primary digester is having problems.

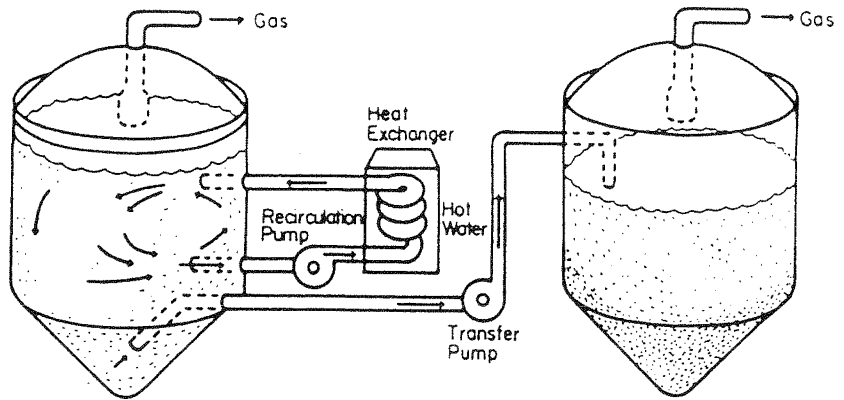

Two-Stage System

### Operation and Maintenance

Operation of an anaerobic digester is similar to any other biological process in a wastewater treatment plant. The hardest part is keeping the methane-forming bacteria alive and producing. While the acid formers can survive in a broad range of environments, methane formers can do so only under very select conditions. Once an anaerobic digester is functioning, those conditions should be maintained, and only small changes should be made. Wide fluctuations of heat, sludge feed rates, etc. could cause the unit to malfunction.

There are five factors which an operator must control to achieve digestion:

Bacteria (seed sludge) must be kept in plentiful supply. In other words, do not remove any more digested sludge than necessary. A good rule is to have about 20 times as much digested (seed) sludge as raw (feed) sludge.

Food for the bacteria is supplied by the primary and secondary sludges pumped to the digester(s). Primary sludge

alone produces the best supernatant and a more easily dewaterable sludge. Secondary sludges tend to reduce supernatant quality. When loading or feeding a digester, the sludge should be concentrated as much as possible and either fed continuously or frequently in small amounts. Digesters should be operated at or near full volumetric capacity.

Mixing the contents of a digester will speed the process of volatile solids reduction and increase gas production by bringing bacteria into contact with the food. This action makes it easier to break down the organic matter.

**EFFECT OF TEMPERATURE  
ON DIGESTION TIME**

TEMPERATURE (DEG. F)	DIGESTION TIME (DAYS)
59	67.8
68	46.6
77	37.5
86	33.3
95	23.7
104	22.7
113	14.4
122	8.9
140	12.6

(NOTE: degree C equals deg F  
minus 32 times 0.55)

Air should not be admitted to an anaerobic digester under any conditions. Methane-forming bacteria cannot tolerate oxygen, even in small amounts. A safety factor is also involved. An explosive mixture can result if air is allowed to come in contact with methane gas. Every precaution should be taken to guard against this happening.

Methane-forming bacteria function best in temperatures ranging from 85-100°F. Bacterial activity is severely reduced outside this range. The performance of methane-forming bacteria can also be seriously affected by temperature fluctuations. Temperature variations of more than 1°F per day can seriously affect the operation of a digester.

The pH is another important factor. A digester can tolerate pH as low as 6.4 or as high as 7.4. But for the best operation, pH should be in the range of 6.8 to 7.2. Methane-forming bacteria are completely inhibited at a pH lower than 6.2.



The pH is probably the most difficult parameter to control. On one hand, the acid-forming bacteria produce organic acids which lower the pH, while, on the other hand, the methane-formers produce CO<sub>2</sub> which provides the sludge with more alkalinity. As long as the process is in balance, the pH will remain close to neutral. Unfortunately, the methane-producing bacteria are more susceptible to changes in their environment than the acid formers. If the environment is altered, even slightly, the methane-producers stop functioning, causing a lower pH. This makes it more difficult for the methane-formers to regrow and the situation deteriorates. For this reason, it is crucial to keep the balance of acid formers and methane formers constant.

One of the more effective control tests combines the volatile acids and alkalinity laboratory tests. The results of these tests are expressed in milligrams per liter, combined as a ratio (volatile acids divided by alkalinity) and expressed as a single number. A good volatile acids/alkalinity ratio will be in the range of 0.1 to about 0.34. When the ratio increases to over 0.35, digester gas production decreases and the pH will drop.

While a pH test (which should be run daily) will show that a digester has started to go “sour” (become more acidic), the volatile acid/alkalinity ratio will show that the process is out of balance long before the pH drops. The volatile acids/alkalinity ratio should be run at least weekly, and more often if the pH is fluctuating.

In addition to the above tests, operators can use their own senses to judge the efficiency of a digester.

An experienced operator can judge sludge thickness, supernatant quality and desirable color for digester sludge by sight. An operator should also note that good quality gas will have a yellow flame with blue at the base of the waste gas burner. Too much yellow indicates an increase in CO<sub>2</sub> production while an orange flame with smoke may indicate a high sulfur content.

By using their ears, operators can detect changes in the raw sludge thickness. If a piston pump begins to “hammer,” it usually indicates that the sludge is thinning out.

The nose can be a useful tool in controlling a digester. By smelling a sludge sample, operators can tell whether it is septic, sour or well-digested. In the case of raw sludge, they should be able to tell whether there are chemicals such as soils, solvents, or other toxic materials which could be harmful to the digester. Also, by smelling supernatant samples, operators may detect a rotten egg odor which indicates organic overload. A rancid butter smell may also be present when heavy metal toxicity exists.

The texture of sludge can sometimes help determine whether too much sand, grease or nondigestible material is in the raw or digested sludge.

### BIOSOLIDS CONDITIONING

Biosolids conditioning is used primarily to aid in the dewatering process which follows. Conditioning typically involves the use of chemicals or heat before dewatering takes place.

The most common chemicals used for conditioning are ferric chloride, lime and polymers. They are often used in combination, but they can be used separately. Raw primary

sludges are sometimes conditioned with lime alone, whereas activated sludges are occasionally conditioned with ferric chloride.

The use of polymers has gained in popularity recently for various reasons. Some of these include the ease of handling, less storage space required, and the effectiveness of polymers for conditioning.

The thermal conditioning involves a process which uses high temperature and pressure to oxidize organic matter. This process has the advantage that the biosolids can be dewatered without the use of chemicals.

There are also some disadvantages to thermal conditioning. The resulting supernatant is high in BOD, ammonia, and volatile acids. This means that additional secondary treatment may be needed to handle the supernatant. Other problems may occur due to gases which are released.

### BIOSOLIDS DEWATERING

Biosolids dewatering is used to remove excess water. This process will reduce the volume of biosolids which need to be managed by creating a damp solid instead of a liquid. Dewatered biosolids should have a minimum of 15 percent total solids in order to be handled as a dry material. This can be accomplished with the use of drying beds, vacuum filters, centrifuges, filter presses, and other less common equipment.

Drying beds are used mainly in rural areas where the amount of biosolids which need to be dewatered is relatively small. Drying beds have a low operating cost and are relatively simple to operate when compared to other methods

of dewatering.

Drying beds dewater biosolids by draining and evaporating water. Biosolids are spread over a bed media which consists of a layer of sand on gravel. A drainage pipe in the gravel allows the water to drain away from the bed and return to the plant for further treatment. Evaporation completes the drying process. Dewatered biosolids can be lifted from the sand without a significant loss of sand. At this point, the total solids content is between 40-60 percent. The dried biosolids are then land applied on farm fields in most cases.

### Sludge Drying Bed

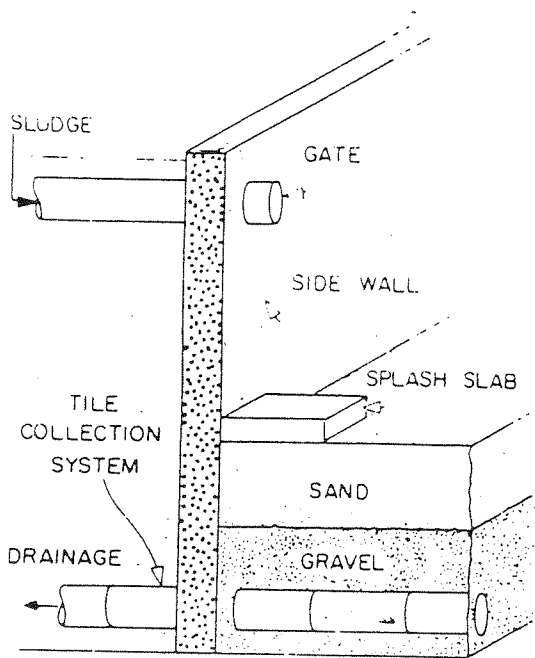

Drying beds are not as practical in Minnesota because of winter conditions. The beds would have to be covered in order to make winter operations possible, making this form of dewatering expensive. Land requirements and labor costs for cleaning and maintaining the drying beds also make this method prohibitive.

Vacuum filters dewater biosolids by rotating a drum containing filter medium through a vat of biosolids and applying a vacuum to the drum. Stainless steel wire mesh, coil springs or cloth made of natural or synthetic fibers are generally used as medium for the filter. A vacuum is placed between the drum deck and the filter medium which extracts the water and returns it to the head of the plant. The solids form a cake on the porous medium which is removed by scraping mechanisms. The sludge cake usually contains 20 to 60 percent of total solids depending on the type of biosolids and filter cycle time.

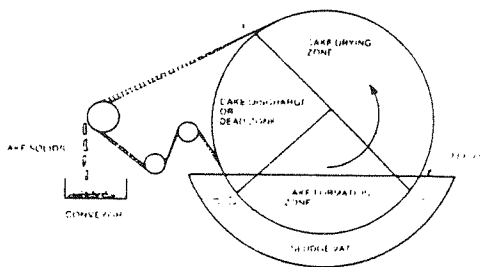

### Rotary Vacuum Filter

Vacuum filtration is not commonly used due to the large amount of space required for the equipment and the cost of operation.

Centrifuges are used to separate solids from liquids by the use of centrifugal force. The three main types of centrifuges which are used for biosolids dewatering are the solid-bowl-conveyor, disc, and basket. All of them operate on the principal of rotating a drum or bowl at high speeds to separate solids from liquids.

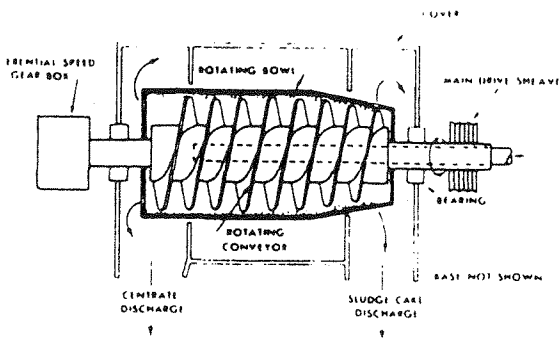

**Solid Bowl-Conveyor  
Centrifuge**

The solid-bowl-conveyer is the most common type of centrifuge used for dewatering. The solid particles in the liquid are pressed together by the centrifugal force to form a cake. The liquid is then returned to the plant's wastewater processing stream and the cake is discharged to a hopper. The total solids content of the cake is 15 to 35 percent.

The disc and basket centrifuges are similar in that the dewatering unit rotates around a vertical axis. The cake is discharged out of the bottom of the unit.

Two disadvantages of using the centrifuge method for dewatering are high maintenance and energy costs; however, centrifuges can generally dewater biosolids without the addition of polymers and the units can be easily cleaned.

Filter presses remove liquid from biosolids by the use of pressure or by squeezing the liquid from the material. The most common type of filter press is called the filter press or plate and frame press. This press does not actually squeeze or press the biosolids as its name would suggest. Rather, pressure is used to force biosolids into cavities between vertical plates which are covered with a filter cloth. After the

pressure is released, the cake falls from the plates and is removed while the filtrate is returned to the head of the plant. Due to the high amount of pressure which is used, a cake is formed which contains 30-50 percent total solids.

Belt pressure filters press biosolids between two filter belts which rotate. The dewatered cake is removed by a scraper. A polymer is usually used for this type of treatment. Belt filtration can produce cakes varying between 15-35 percent total solids.

### Belt Pressure Filter

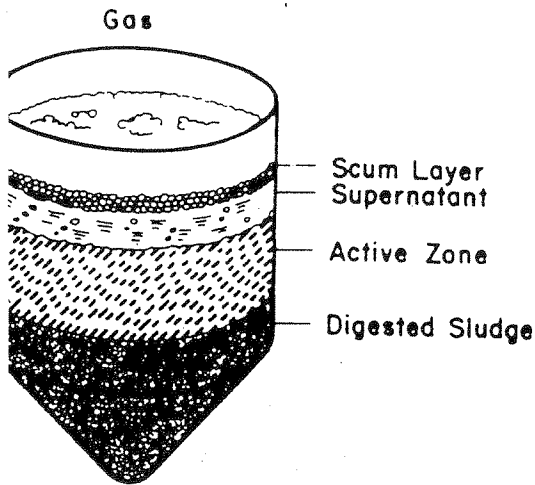

Open-Top, Unheated,  
Unmixed Digester

### STORAGE

Biosolids can be stored in tanks, pits or lagoons before it is disposed of elsewhere or land applied. While storage does not provide much treatment, the amount of biosolids can be reduced if allowed to settle and the supernatant removed.

Holding tanks and lagoons are sized to provide detention times needed based on the final use or disposal of biosolids. For example, if biosolids are land applied, it is necessary to construct enough storage to fit into the typical crop rotations used in the area and when fields cannot be accessed because of bad weather.

Operation is quite simple; biosolids are sent to the holding tank or lagoon as necessary. Supernatant is usually drawn off and sent back to the head of the treatment plant when enough has accumulated. Biosolids are removed when the tank or lagoon is full.

## BIOSOLIDS OPTIONS FOR UTILIZATION OR DISPOSAL

The three most common methods for management of biosolids are land application, incineration, and landfilling. The alternative selected is dependent on many factors, including cost, availability of land, and public acceptance.

Land Application - Biosolids contain organic matter, plant nutrients (nitrogen, phosphorus, and essential trace elements) which make its application on land a viable alternative for management. Biosolids may be used as a fertilizer and conditioner for the soil. This type of use is preferable to disposal-type operations such as landfilling. Rules are in place for the proper management of biosolids which are land applied.

Biosolids must be stabilized by digestion prior to land application. For more information on land applying biosolids, please see the Land Application of Biosolids Manual which is listed in the references.

Incineration - Incineration as a method of disposal is commonly used by facilities which handle large volumes of biosolids. This method may be more cost effective for treatment facilities which would have to transport biosolids long distances to use other alternatives for disposal.

High energy costs, strict air pollution control standards, and the need for dewatering, has made incineration undesirable for most smaller facilities. The ash produced from incineration of biosolids must be managed as a solid waste.

Landfilling of biosolids is not widely used in Minnesota as an option for disposal. In addition, this option may involve a higher cost of disposal and not all landfills are permitted to accept biosolids. In order for biosolids to be landfilled, they must be dewatered.

## REFERENCES

1. Operations Manual - Anaerobic Sludge Digestion, (EPA 430/9-26-00) U.S. Environmental Protection Agency.
2. Operation of Wastewater Treatment Plants, Manual of Practice No. 22, Water Pollution Control Federation.
3. Field Manual for Performance Evaluation and Troubleshooting at Municipal Wastewater Treatment Facilities, (EPA-430/9-78-001) U.S. Environmental Protection Agency.
4. Operations Manual - Sludge Handling and Conditioning, (EPA-430/9-78-002) U.S. Environmental Protection Agency.
5. Sludge Treatment and Disposal, Volumes No. 1 and 2, (EPA-625/4-78-012) U.S. Environmental Protection Agency.
6. Land Application of Biosolids Manual, Minnesota Pollution Control Agency.





# SAMPLING

## TABLE OF CONTENTS

	<u>PAGES</u>
<u>INTRODUCTION</u>	199
<u>SAMPLING PRINCIPLES</u>	199
Representative Samples	
Sample Types	
Procedure	
Sampling Locations	
Sampling Equipment	
Laboratory Equipment/Tests	
Sample Preservation	
<u>REPORTING RESULTS</u>	208
<u>REFERENCES</u>	209

## INTRODUCTION

Why is it necessary for operators to spend their valuable time sampling? Some of us might answer that by saying: "Because our permit says we have to!" While each wastewater treatment facility must meet and demonstrate its ability to comply with effluent limits listed in their permit, this should not be the only reason for taking samples. In order to determine how efficiently various treatment processes or units are operating and to make decisions on overall operational procedures, certain information is needed. For the most part, this information is obtained from laboratory results. If these results are from samples collected improperly, poor decisions may be made and resampling will be necessary. Therefore, it is extremely important to follow these basic sampling principles:

## SAMPLING PRINCIPLES

- 1) Samples should be representative of what is in the wastes stream;
- 2) Use proper sampling techniques; and
- 3) Preserve the samples until they are analyzed.

### Representative Samples

A sample must represent the characteristics of the wastewater being sampled. As you have probably seen, the quality and composition of wastewater can change over time. It can also vary in composition at different locations. Therefore, samples should be taken only where the

**Sample Should Be Well  
Mixed**

wastewater is well mixed. If large particles are found in the sample, they should be broken up to make a more uniform sample. Deposits or growths of floating material which have formed at the sampling point should not be included in the sample. If samples are collected in channels or near tank walls, care must be used to prevent scraping of solids from the walls. Unless a representative sample is taken, results may be in error and totally meaningless.

Sample Types

**Grab Sample**

There are two types of samples which are used at most wastewater treatment plants; the grab sample and the composite sample. The grab sample is a single sample collected at one instant. Certain tests, such as pH, chlorine residual, dissolved oxygen and fecal coliform, require grab samples because the results can change very quickly once the sample is removed from the flow.

**Composite Sample**

A composite sample is made up of individual grab samples collected over a specified period of time and combined. There are two types of composite samples: fixed volume and flow-proportioned. The fixed volume composite is sometimes referred to as a simple composite. When collecting a fixed volume composite, both the sample size and the time interval remain constant. This sample type can be used only if the flow rate of the waste stream being sampled remains fairly constant (flow rate should not vary more than 15 percent from the average). A flow-proportioned composite sample is used when the waste stream flow rate is variable. Because most wastewater treatment facility flow rates are variable, NPDES permits

**Flow Proportion  
Each Sample**

typically require flow-proportioned composite samples. As the name implies, with a flow-proportioned composite sample the volume of each sample collected is in proportion to the flow rate at the time of collection.

Composite samples can be collected by automatic samplers or manually. Most automatic samplers can be connected to flow meters to automatically collect a flow-proportioned composite. If the automatic sampler does not flow-composite, or if you collect samples manually, it will be necessary to flow-composite the individual samples. In order to properly proportion each sample, the flow rate must be known for the time each grab sample is collected.

The volume required from each grab sample is determined by the following formula:

$$\text{Volume Required*} = \frac{\text{flow rate times total sample required}}{\text{average flow rate times number of samples to be collected}}$$

**\*Note:** The volume required for each grab sample must be calculated using the flow rate at the time of collection.

Example:

Flow rate (at time of one grab sample) is 100,000 gpd.

Average flow rate is 200,000 gpd.

Total sample size required is 2,000 ml.

Number of samples to be collected is 8.

$$\text{Volume Required} = \frac{100,000 \times 2,000}{200,000 \times 8} = 125 \text{ ml}$$

As noted above, the volume required calculation must be done for each grab sample used for the flow-composite sample.

## Four-Hour Composite

The following is a similar procedure for conducting a four-hour flow-composite sample: Obtain a large (two and one-half gallon or greater) clean sample container, a bottle for your final sample container (to be used to forward sample to testing laboratory), and something to accurately measure liquids (such as a large graduated cylinder). A refrigerator or ice will also be needed to keep the composited sample as close as possible to 4°C (39°F).

The four-hour composite should be collected over the four-hour period you feel will be most representative of the entire day's flow. At least one sample should be collected each hour.

### Procedure

#### Estimate Average Flow

1) Estimate what the average flow will be over the sampling period. The easiest way to make a reasonably accurate guess is to check your flow charts for the last few days (not including weekends) for the same time period as you will be sampling.

#### "K" Value

2) Select the "K" value corresponding to your average flow determined in Step 1 from the following four-hour composite table (e.g., the "K" value for 95 gallons per minute would be 15). The selected "K" value should be used for the entire four-hour composite sampling period.

#### Estimated Flow

<u>Gallons Per Minute</u>	<u>"K"</u> <u>Value</u>
1 to 4	500
5 to 9	200
10 to 20	100

21 to 50	40
51 to 100	15
101 to 350	7
351 to 1,000	2

### Take Sample

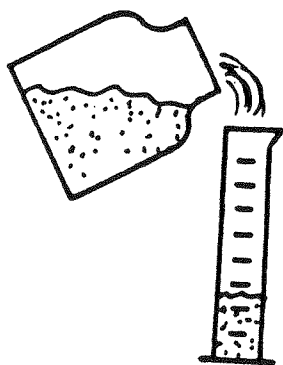

- 3) Collect your first sample at the beginning of the time interval you selected and note the influent flow to your plant. Multiply this flow times the “K” value you found in Step 2 to determine the amount of sample (in milliliters) to add to your large sample container. Example: If the flow to your facility is 80 gallons per minute at the time the sample is collected, you should add 1,200 milliliters to the sample container since  $80 \times 15 = 1,200$ .
- 4) Thoroughly mix your sample, measure the amount determined in Step 3 in a graduated cylinder and pour it into the container. Place this in the refrigerator or pack it in ice.
- 5) Continue sampling each hour during the sampling period and add the required amount to the sample container each time as done in Steps 3 and 4 (be sure to use the flow rate corresponding to each sampling time).
- 6) After the last sample has been added to the sample container, stir the composite sample vigorously and then pour out the amount required for analysis into the final composite bottle. Keep this sample refrigerated or packed in ice until analysis.

### Sampling Locations

As previously stated, samples must be representative of what is in the waste stream. Some examples of appropriate sampling points are:

- 1) Raw Influent - Samples from the incoming wastewater should be collected after bar screens and comminutors to avoid the problem of large objects or deposits. Unless absolutely necessary, do not take an influent sample from the wet well. If such a sample is necessary, it should be taken as closely as possible to where the wastewater enters the wet well.
- 2) Aeration Tank Contents - Samples should be taken at locations having the most turbulence and mixed together into one sample for analysis.
- 3) Clarifier Effluent - Samples should be taken at a point after the discharge from the effluent trough, weir or pipe. It should not be taken from one isolated spot within the clarifier, or from just one overflow point of discharge weir.
- 4) Fecal Coliform - The sample should be collected at a location after chlorination and as close as possible to the point of discharge from the treatment plant.
- 5) Raw Sludge - Samples may be collected from pipe taps near the sludge pump or from the pump itself. Sample portions should be discharged into a pail several times during the pumping operation. The contents should be well mixed before removing a sample for analysis.



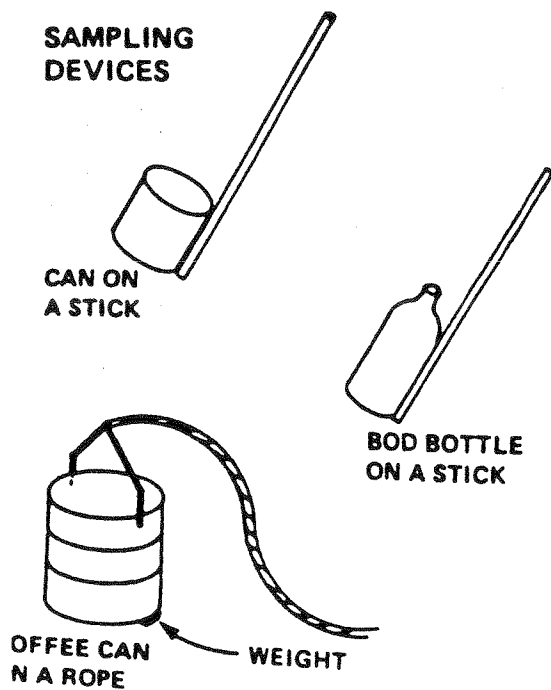

**Sterilized Container**

### Sampling Equipment

Various types of sampling equipment can be purchased from suppliers. Also, operators can make much of their own equipment. A long-handled dipper with a wide-mouth container of corrosion-resistant material is recommended for sampling for biochemical oxygen demand and total suspended solids. The sampling container should be clean before each sample is taken. It is preferable to use a separate sampler for each location.

When sampling for fecal coliform, you should never use the same sampler as the one which raw influent or effluent was collected in. Contamination will result even if the sampler is washed before collecting the fecal coliform sample. Fecal coliform samples must be collected directly into a separate sterilized container. A fecal coliform sampler can be made by attaching a clamp or wire loop at the end of a long pole or rod for holding a sterilized "whirlpak" type bag.

### Laboratory Equipment/Tests

All analytical tests required in your permit must be conducted using approved laboratory procedures. Consult your NPDES permit for a list of references which describe the required procedures.

The equipment needed to perform the required analytical tests for your facility can be purchased from many suppliers. In the long run, it is probably best to do your own testing whenever possible. However, it should be pointed out that in some cases, the costs for time and laboratory equipment may not justify doing all of the testing. In this

**Operator Should  
Collect Sample**

case, the community may choose to have a private testing firm conduct required tests or make arrangements with a neighboring community which has laboratory facilities. Regardless of who does the testing, the operator should collect the samples. In addition, the operator should also conduct the settleable solids, pH, dissolved oxygen, and chlorine residual tests at the time they are collected. Because these analyses must be conducted at the time they are collected, all facilities must have the necessary equipment. The following is a brief description of these tests:

Settleable Solids - Settleable solids are that part of total solids which settle out during a specific time period (usually one hour). Settleable solids are measured with an Imhoff cone. The results are measured in milliliters per liter and are an indication of the solids removed by settling such as in clarifiers. Some typical results are listed below:

**Imhoff Cone**

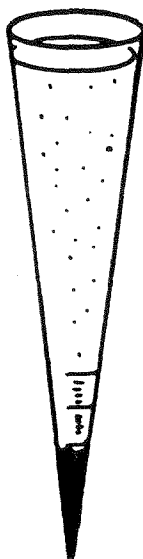

<u>Sample</u>	<u>Common Range, mg/l</u>
Influent	8 ml/l - weak 12 ml/l - medium 20 ml/l - strong
Effluent (from secondary treatment)	Trace to 0.5 ml Over 0.5 ml/l - poor removal

pH - pH is a measure of the alkaline (basic) or acid strength of a substance. The pH scale ranges from 0 to 14 with a pH of 7 being neutral. Anything less than 7 is considered an acid, and anything above 7 is basic or alkaline. Normal biological activity is considered best in a pH range from 6 to 9. Measurement of pH is done with a pH meter. Some common ranges for pH are listed below.

<u>Sample</u>	<u>Common Range</u>
Influent or Raw Domestic Wastewater	6.8 to 8.0
Raw Sludge (Domestic)	5.6 to 7.0
Effluent (depending on type of treatment)	6.8 to 8.0

Dissolved Oxygen - Dissolved oxygen is the amount of oxygen dissolved in the water or wastewater. Its presence encourages the growth of aerobic bacteria. There are various procedures used to measure the amount of dissolved oxygen. The two most common are the azide modification of the Winkler method and the dissolved oxygen meter. Some common ranges for dissolved oxygen concentrations are:

<u>Sample</u>	<u>Common Range, mg/l</u>
Influent	1
Secondary Effluent	3 to 8
Stabilization Ponds	1 to 15
Activated Sludge (Aeration Tank Outlet)	1 to 3

### **Chlorine Remaining**

Chlorine Residual - The amount of chlorine remaining in the effluent after chlorination is normally called the chlorine residual. Studies have shown that even very low residuals can have toxic effects on fish and aquatic life. For this reason, some facilities may be required to dechlorinate. Accurate residual measurement of wastewater entering a receiving water is, therefore, necessary. A chlorine residual of 0.5 mg/l is generally adequate to meet the disinfection requirement. The following methods have been approved for measurement of chlorine residual:

- 1) Iodometric Titration
- 2) Amperometric Titration
- 3) DPD Colorimetric (with spectrophotometer or filter photometer only)
- 4) DPD Titrimetric

Previously, quick measurements of chlorine residuals by the orthotolidine or “color wheel” method were used. However, various problems caused measured values to be much less than actual concentrations, leading to overchlorination. Because of this, orthotolidine is no longer accepted as a method to measure chlorine residual.

#### Sample Preservation

The time interval between collection and analysis should be minimized as much as possible. Whenever there will be an extended period of time between collection and analysis, the sample should be refrigerated (or packet in ice) to a temperature as close as possible to 4°C. No sample should be held for more than 24 hours prior to being analyzed. In addition, dissolved oxygen and pH analyses must be conducted immediately and fecal coliform should be conducted within six hours.

#### **Sample Should Be Refrigerated**

#### REPORTING RESULTS

A complete listing of required frequency of tests and observations is included in your NPDES permit. As an operator, you should consult your permit often enough to become thoroughly familiar with its contents.

## Monthly Reports

As with everything else, the job is not done until the paper work is finished. The laboratory results from the samples you have taken should be entered on the discharge monitoring report form. One copy should be kept in your files and another sent to the address noted on the form by the date specified in your permit.

## REFERENCES

1. Standard Methods for Examination of Water and Wastewater, American Public Health Association.
2. Handbook for Monitoring Industrial Wastewater, Association Water and Air Resources Engineers.
3. Wastewater Plant Operators Manual, State of Washington.
4. Operation of Wastewater Treatment Plants, Water Pollution Control Federation.
5. Manual of Instruction for Wastewater Treatment Plant Operators, New York State Department of Environmental Conservation.
6. Operation of Wastewater Treatment Plants, California State University, Sacramento.

**WASTEWATER  
TREATMENT  
TECHNOLOGY**

**GLOSSARY**

## GLOSSARY

### **A**

#### **Absorption**

The taking up of one substance into the body of another by chemical or molecular action

#### **Acid**

- 1) A substance which dissolves in water with the formation of hydrogen ions.
- 2) A substance containing hydrogen which may be replaced by metals to form salts.

#### **Acre-Foot**

A volume term referring to an amount of liquid one acre in area and one foot deep (43,560 cubic feet or use 326,000 gallons).

#### **Activated Sludge**

Sludge floc produced in an aeration tank by the growth of organisms in the presence of dissolved oxygen ("activated" - sludge teaming with active, or living, micro-organisms, such as bugs).

#### Contact Stabilization Process

A modification of the activated sludge process in which wastewater is aerated for a short period, usually less than 60 minutes, to obtain BOD removal. Solids are subsequently separated by sedimentation and transferred to a stabilization (reaeration) tank where aeration is continued, starving the activated sludge before returning it to the aeration basin.

#### Conventional Process

Activated sludge process using plug-flow through the aeration basin, with wastewater and return sludge fed at the head end and uniform aeration throughout.

#### Extended Aeration

A modification of the activated sludge process using very long aeration periods, i.e., 18-24 hours.

### Oxidation Ditch

A modification of the extended aeration activated sludge process.

### **Adsorption**

The attachment of material onto the surface of an organism.

### **Aerated Pond**

A wastewater treatment pond in which mechanical or diffused-air aeration equipment is used to supply the dissolved oxygen.

### **Aeration**

The process of adding air to liquid by one or more of the following methods: (a) spraying the liquid in the air, (b) bubbling air through the liquid, and (c) agitating the liquid to promote surface absorption of air.

### **Aerobic**

A condition in which "free" or dissolved oxygen is present in the aquatic (water) environment.

### **Aerobic Bacteria**

Bacteria which require free dissolved oxygen for growth.

### **Aerobic Digestion**

The breakdown of waste by micro-organisms in the presence of dissolved oxygen. Waste sludge is placed in a large aerated tank where aerobic micro-organisms decompose the organic matter in the sludge.

### **Aerosols**

Microscopic droplets dispersed in the atmosphere.

### **Air Test**

A method of inspecting a sewer pipe for leaks: inflatable plugs are placed in the line; the space between these plugs is pressurized with air - a drop in pressure indicates leaks in the line being tested.

### **Algae**

Primitive one or many-celled plants, usually aquatic, which are capable of producing their food from carbon dioxide and water through photosynthesis.

### **Algae Blooms**

Large masses of microscopic and macroscopic plant life, such as green algae, occurring in bodies of water.

### **Algicide**

Any substance or chemical applied to kill or control algal growths.



<b>Alkalinity</b>	The capacity of water or wastewater to neutralize acids. This capacity is caused by the water's content of carbonate, bicarbonate, hydroxide and occasionally borate, silicates and phosphate. alkalinity is a measure of how much acid can be added to a liquid without causing a great change in pH.
<b>Amperage</b>	The strength of an electric current measured in amperes (amps).
<b>Amperometric Titration</b>	An electrometric method of detecting chlorine residual
<b>Anaerobic</b>	A condition in which "free" or dissolved oxygen (O <sub>2</sub> ) is not present.
<b>Anaerobic Bacteria</b>	Bacteria which grow in the absence of free dissolved oxygen and must obtain their oxygen by chemically breaking down organic compounds which contain combined oxygen.
<b>Anaerobic Digestion</b>	A process whereby wastewater solids are placed in a large tank where bacteria decompose the solids in the absence of dissolved oxygen.
<b>Annual Crop</b>	A crop which completes its entire life cycle and dies within one year or less; e.g., corn, beans.
<b>Appurtenance</b>	Machinery, appliances, apparatus and other accessory parts necessary to allow the main structure to operate as intended, but not considered a part of the main structure.
<b>Aquifer</b>	A porous, water-bearing geologic formation generally restricted to materials capable of yielding an appreciable supply of water.
<b>Asphyxiation</b>	An extreme condition, often resulting in death, due to a lack of oxygen and an excess of carbon dioxide in the blood (also called suffocation).
<b>Available Water Capacity</b>	Soil's capacity to hold water against the force of gravity expressed as inches of water per inch of soil.

## **B**

<b>Backfill</b>	<ol style="list-style-type: none"><li>1) Material used to fill in a trench or excavation;</li><li>2) The act of filling a trench or excavation, usually after a pipe or some type of structure has been placed in the trench or excavation.</li></ol>
<b>Bacteria</b>	Primitive one or many-celled organisms, microscopic in size, which use organic matter for their food.
<b>Baffle</b>	Short wall, usually in a clarifier, to distribute flow. Also used to keep scum from floating out the effluent.
<b>Balling</b>	A method of hydraulically cleaning a sewer or storm drain by using the pressure of a water head to create a high-cleansing velocity of water around the ball. The method is best used for cleaning grease, grit, and other debris which would normally be handled by flushing the sewers, except that this does it better.
<b>Bar Screen</b>	A screen usually consisting of equally spaced parallel bars, for trapping roots, branches, rages, and other large material which may be found in the wastewater flow.
<b>Barrell</b>	<ol style="list-style-type: none"><li>1) The cylindrical part of a pipe which may have a bell on one end.</li><li>2) The cylindrical part of a manhole between the cone at the top and the shelf at the bottom.</li></ol>
<b>Bedding</b>	The prepared base of a trench or excavation on which a pipe or other underground structure is supported.
<b>Bell</b>	The recessed, over-enlarged female end of a pipe which the male end fits into, also called a hub.
<b>Biochemical Oxygen Demand (BOD)</b>	<ol style="list-style-type: none"><li>1) The quantity of oxygen required by microscopic organisms for stabilizing, or using as food, organic materials in wastewater in a specified time and at a specified temperature (normally five days at 20°C).</li><li>2) A standard test used in evaluating wastewater strength.</li></ol> <p>SEE: CARBONACEOUS BIOCHEMICAL OXYGEN DEMAND (CBOD)</p>

<b>Biological Wastewater Treatment</b>	A form of wastewater treatment in which microbial or biochemical action is intensified to stabilize the unstable organic matter present and to remove nonsettling solids.
<b>Biomass</b>	A living mass of organisms.
<b>British Thermal Unit (BTU)</b>	The amount of heat required to raise the temperature of one pound of water 1°F.
<b>Bucket Machine</b>	A powered winch machine designed for operation over a manhole which controls the movement of buckets used to clean sewers.
<b>Bulking Sludge</b>	Sludge which settles poorly.
<b>Bypass</b>	A pipe or conduit which permits wastewater to flow around a wastewater treatment plant or any unit of the plant.
<b>C</b>	
<b>Carbonaceous Biochemical Oxygen Demand (CBOD)</b>	A modified BOD procedure in which a nitrification inhibitor is used to prevent measuring oxygen uptake due to ammonia reduction. The results from this procedure, therefore measure <u>only</u> the oxygen used by the micro-organisms to break down the wastewater's carbonaceous organic material.
	SEE: BIOCHEMICAL OXYGEN DEMAND (BOD)
<b>Catch Basin</b>	A chamber or well used with storm or combined sewers to remove grit which might otherwise enter and be deposited in sewers.
<b>Cation</b>	An ion or molecule which has a positive electrical charge.
<b>Cation Exchange Capacity</b>	The number of exchangeable cations which a soil can adsorb expressed in milliequivalents per 100 grams of soil.
<b>Caustic</b>	That which can burn, eat away or destroy living tissue by chemical action, corrosive.

<b>Cavitation</b>	The information and collapse of a gas bubble on the blade of a pump impeller. The collapse of this gas bubble drives water into the impeller with a force terrific enough to be able to cause pitting on the impeller surface.
<b>Centrifugal Pump</b>	Pump consisting of an impeller fixed on a rotating shaft and enclosed in a casing having an inlet and discharge connection. A rotating impeller creates pressure in the liquid from centrifugal force.
<b>Centrifuge Test</b>	(Spin test) method of estimating amount of solids in a sample by the use of a centrifuge.
<b>Chemical Oxygen Demand (COD)</b>	A measure of the oxygen-consuming capacity of organic materials in water or wastewater. This is expressed as the amount of oxygen consumed from a chemical oxidant.
<b>Chelating Properties</b>	The property of certain chemical compounds in which a metallic ion is firmly combined with a compound with multiple bonds. Chelate means claw.
<b>Chlorination</b>	The application of chlorine to water or wastewater for the purpose of disinfection, oxidation, odor control, or other effects (prechlorination - before treatment; post-chlorination - after treatment; in-process chlorination - during treatment).
<b>Chlorinator</b>	A device used to regulate the transfer of chlorine from a container to flowing water for such purposes as odor control and disinfection.
<b>Chlorine</b>	An element having strong disinfecting and oxidizing properties.
<b>Chlorine Contact Chamber</b>	A detention basin provided in a treatment facility primarily to make sure that chlorine has enough time to disinfect the water.
<b>Chlorine Demand</b>	The amount of chlorine required to be added to water or wastewater before a residual of free chlorine can be obtained.
<b>Chlorine Dosage</b>	The amount of chlorine added to the wastewater.

<b>Chlorine Residual, Total</b>	The total of free and available combined chlorine. Available combined chlorine may be in the form of chloramines and is not as potent a disinfectant as free chlorine.
<b>Chlorine Residual, Free</b>	The amount of chlorine added to water or wastewater in excess of the demand.
<b>Chlorogenic</b>	Organic compounds combined with chlorine -- generally result from or are associated with living or dead organic material.
<b>Ciliates</b>	A class of protozoans distinguished by short hairs on all or part of their bodies.
<b>Circuit</b>	The complete path of an electric current, including the generating apparatus or other source, or a specific segment or section of the complete path.
<b>Circuit Breaker</b>	A safety device in an electrical circuit with automatically shuts off the circuit when it becomes overloaded.
<b>Clarifier</b>	A settling tank, sedimentation tank or basin in which wastewater is held for a period of time in which the heavier solids settle to the bottom and the light solids float to the water surface.
<b>Clean-out</b>	A point of access to a wastewater collection system or forcemains and in-plant piping for insertion of tools, rods or snakes to allow sewer cleaning.
<b>Coagulants</b>	Chemicals added to destabilize and bind together colloids and solids to improve their settling characteristics.
<b>Collection System</b>	A network of pipes, manholes, cleanouts, traps, siphons, lift stations and other required structures for collecting all wastewater of an area. Collection systems transport the wastewater to a treatment plant or disposal system (includes land, wastewater lines and appurtenances, pumping stations, and general property).
<b>Colloids</b>	Very small solids (particulates or insoluble material) in a finely divided form which remain dispersed in a liquid for a long time due to their small size and electrical charge.

<b>Combined Sewer</b>	Sewer intended to receive both wastewater and storm water.
<b>Comminutor</b>	A device used to reduce the size of solids in wastewater by shredding (comminuting).
<b>Compaction Test</b>	Any method of determining the weight which a compacted material is able to support without damage or displacement -- usually stated in pounds per square foot.
<b>Composite Samples</b>	Samples collected at regular intervals in proportion to flow and then combined to form a sample representative for the entire period of time.
<b>Coning</b>	A condition which may occur in a sludge hopper during sludge withdrawal. Part of the sludge moves toward the outlet while the remainder tends to stay in place -- development of a cone or channel of moving liquid surrounded by relatively stationary sludge.
<b>Control Structure</b>	A shallow structure used to regulate the flow of water in a stabilization pond system.
<b>Cover Crop</b>	A crop grown between periods of regular crops for adding organic matter to soil or to protect soil from erosion.
<b>Cradle</b>	A device used to support a pipe.
<b>Cross Braces</b>	Shoring members placed across a trench to hold other horizontal and vertical members in place.
<b>Cross Connection</b>	<ol style="list-style-type: none"> <li>1) A connection between a storm sewer system and a sanitary sewer collection system.</li> <li>2) A connection through which a supply of potable water could be contaminated or polluted.</li> </ol>
<b>Curb Inlet</b>	An opening at the curblines of a street for admitting gutter flow to the storm water collection system.

## D

<b>Decomposition (Decay)</b>	Generally, any biological process which converts unstable materials into more stable forms by chemical or biological action.
<b>Deflected Pipe</b>	<ol style="list-style-type: none"><li>1) A pipe which has been forced out of round by external pressures -- mainly applicable to fiberglass and plastic pipes where backfill compaction has resulted in unequal pressures on all sides of the pipe.</li><li>2) A pipe whose direction has been changed either to the left, right, up, or down.</li></ol>
<b>Denitrification</b>	A biological process by which bacteria, under low DO conditions, use nitrates for their source of oxygen in their metabolic processes; nitrogen gas is released in the process and can result in floating sludge on clarifiers following secondary treatment.
<b>Detention Time</b>	The theoretical time required for a given flow of wastewater to pass through a tank (volume divided by flow rate), or the time required to fill a tank at a given flow.
<b>Dewater</b>	<ol style="list-style-type: none"><li>1) To drain or remove water form an enclosure.</li><li>2) Draining or removing water from sludge to increase the solids concentration.</li></ol>
<b>Diffused Air Aeration</b>	The process by which air is compressed and discharged below the water level surface through some type of air diffusion device.
<b>Diffuser</b>	A device (porous plate, tube, bag, etc.) used to break the air stream from a blower system into small bubbles in a liquid.
<b>Digester</b>	A tank in which sludge is placed to further break down the organic matter and reduce the number of pathogens.
<b>Discharge</b>	Any flow of effluent from a treatment unit.
<b>Disinfection</b>	The process by which pathogenic (disease-causing) micro-organisms are reduced. Chlorination is the most frequently used method in wastewater treatment.

<b>Dissolved Oxygen</b>	Free or chemically uncombined oxygen existing in solution (dissolved) with water or other liquid and normally expressed as milligrams per liter.
<b>Distributor</b>	The rotating mechanism which distributes wastewater evenly over the surface of a trickling filter.
<b>Diurnal</b>	Having a daily cycle.
<b>Domestic Wastewater</b>	Human wastewater originating from residences, business buildings, institutions, and the like.
<b>Dry Well</b>	A dry room or compartment in a lift station, separate from the wet well, where pumps are located.
<b>E</b>	
<b>Easement</b>	Land owned by others in which a utility agency has a legal right to use the land in order to install and maintain a line, such as a sewer.
<b>Effluent</b>	Wastewater or other liquid flowing <u>from</u> a basin, treatment process, or treatment plant.
<b>Electrical Conductivity</b>	The readiness or ease with which an electrical impulse flows through water or soil.
<b>End Point</b>	Samples titrated to the end point; this means that a chemical is added, drop by drop, to a sample until a certain color change (blue to clear for example) occurs, which is called the end point of titration. In addition to a color change, an end point may be reached by forming a precipitate or by reaching a specific pH. Also, an end point may be detected by using an electronic device such as a pH meter.
<b>Endogenous Respiration</b>	The process whereby a living organism uses its own stored cellular materials as an energy source in the absence of fresh food supplies.
<b>Enzymes</b>	Substances produced by bacteria which speed up chemical changes and are used in their digestion process.



<b>Escherichia Coli (E. Coli)</b>	A species of bacteria which are normal inhabitants of the intestine of man and other warm-blooded vertebrates.
<b>Eutrophication</b>	The process in which the rate of plant growth is faster than the rate of organic material decomposition. This is caused by an abundance of nutrients in the water (nitrogen, phosphorus, potassium and minor nutrients).
<b>Evapotranspiration</b>	The combined loss of water to the atmosphere from plant transpiration and surface evaporation.
<b>Exfiltration</b>	Liquid wastes and liquid-carried wastes which unintentionally leak out of a sewer-pipe system and into the environment.
<b>F</b>	
<b>Facultative Bacteria</b>	Bacteria which can adopt to aerobic or anaerobic conditions - can use dissolved or combined oxygen.
<b>Fallow Land</b>	Land which is uncropped and is kept cultivated during the growing season.
<b>Fecal Coliform Bacteria</b>	Bacterial organisms present as a result of direct fecal contamination - those bacteria which normally inhabit the intestines of warm-blooded vertebrates.
<b>Filamentous Bacteria</b>	Organisms which grow in a thread-like filamentous form.
<b>Flap Gate</b>	Gate which opens and closes by rotation around a hinge or hinges at the top side of the gate.
<b>Flights</b>	Scraper boards, usually made from redwood or other rot-resistant wood, used to collect and move settled sludge or floating scum.
<b>Float</b>	A device used to measure the elevation of the water surface. A float rests on the surface of the water and rises or falls with it; elevation of the water surface is measured by a rod, chain, rope or tape attached to a float.

<b>Float Line</b>	A length of rope or heavy twine attached to a float, plastic jug, or parachute to be carried by the sewer flow from one manhole to the next.
<b>Flocculated</b>	An action resulting in the clumping of fine particles to form larger particles.
<b>Flood Plain</b>	Any area adjacent to a water course which is subject to flooding during periods of high water flows. Flood plain is often used with numbers (5, 10, 50, 100 year) to indicate the frequency of flooding at a given elevation.
<b>Flume</b>	An open conduit of wood, masonry, metal or plastic constructed on a grade and sometimes elevated, called an aqueduct or channel. Normally used to measure flow rate.
<b>Food Chain Crop</b>	A crop such as tobacco or crops grown for direct human consumption or for animal feed whose products are consumed by humans.
<b>Forage Crops</b>	A crop such as hay, pasture grass, alfalfa or others which are grown primarily for animal feed.
<b>Forcemain</b>	A pipe which conveys wastewater under pressure from the discharge side of a pump to a point of gravity flow.
<b>Freeboard</b>	The vertical distance from the normal water surface to the top of a confining wall or dike.
<b>G</b>	
<b>Glacial Outwash</b>	Soils which result from glaciers melting and depositing soil which has similar texture in layers.
<b>Glacial Till</b>	A mixture of soil textures which were deposited by glaciers as they receded. Particle textures and sizes are mixed with no distinct layers.
<b>Grab Sample</b>	A single sample of wastewater taken at one time from one place.

<b>Grade</b>	<ol style="list-style-type: none"> <li>1) The elevation of the bottom of a pipeline, canal, culvert, sewer, or similar conduit.</li> <li>2) The slope of a sewer, conduit, stream channel, or natural ground surface -- usually expressed in terms of the vertical rise or fall per unit of horizontal distance.</li> </ol>
<b>Grit</b>	The heavy mineral material present in wastewater, such as sand, coffee grounds, eggshells, gravel, and cinders. Grit tends to settle out at flow velocities below 2 feet/ second.
<b>Grit Chamber</b>	A detention chamber or an enlargement of a collection line designed to reduce the flow velocity to permit separation of grit from organic solids by sedimentation.
<b>Ground Water</b>	Subsurface water occupying the saturation zone from which wells and springs are fed. In a strict sense, the term applies only to water below the water table.
<b>Ground Water Recharge</b>	Any area where surface waters are returned to the ground water.
<b>Ground Water Table</b>	The average depth or elevation of ground water over a selected area.
<b>Grout</b>	A substance in a paste or liquid form which solidifies after placement or treatment -- used to fill spaces, holes or voids in other materials.
<b>H</b>	
<b>Head</b>	A head of water may be measured in either height (feet) or pressure [pounds/square inch (psi)]. A way of expressing pressure in terms of the height of a vertical column of water.
<b>Head Loss</b>	Resistance to flow or reduction in pressure in a pipe due to friction from pipes, elbows, pumps, etc.
<b>Heavy Metals</b>	Certain elements found in wastewater or sludge which may destroy crops or enter the food chain through crops (e.g., mercury, cadmium, nickel, copper, zinc and lead).

<b>High-Velocity Cleaner</b>	A machine designed to remove grease and debris from sewer pipes with jets of high-velocity water -- also called a "Jet Cleaner," "Jet Rodder," "Hydraulic Cleaner," or "High-Pressure Cleaner."
<b>Humus</b>	Organic matter in the soil which has reached the advanced stages of decomposition. It is usually dark colored, has high nitrogen content, holds water and has a high cation exchange capacity.
<b>Hydraulic Loading</b>	The total volume of water flowing through a facility or structure over a specified time period.
<b>Hydrogen Sulfide Gas (H<sub>2</sub>S)</b>	A flammable, explosive, poisonous gas with a rotten-egg odor found in wastewater collection systems.
<b>Hydrology</b>	The science concerned with the waters of the earth in all their states -- their occurrence, distribution and circulation through the unending hydrologic cycle of precipitation, stream flow, infiltration, storage, runoff, evaporation and reprecipitation.
<b>I</b>	
<b>Imhoff Cone</b>	A cone-shaped graduated vessel used to measure the volume of wastewater settleable solids.
<b>Imhoff Tank</b>	A two-story sedimentation and sludge-digestion tank.
<b>Impeller</b>	A rotating set of vanes in a pump designed to pump or lift water.
<b>Industrial Wastewater</b>	Liquid waste originating from industrial processing.
<b>Infiltration</b>	Extraneous water entering a sanitary sewer system through joints and cracks in the sewer after having traveled through soil.
<b>Infiltration/Inflow</b>	The total quantity of water from both infiltration and inflow without distinguishing the source.

<b>Inflow</b>	Extraneous water entering a sanitary sewer system by direct connection from roof drains, basement sumps, manhole covers, etc.
<b>Influent</b>	Wastewater or other liquid flowing <u>into</u> a reservoir, basin, treatment process or treatment plant.
<b>Interceptor</b>	A sewer which receives flow from a number of other large sewers or outlets and conducts the water to a point for treatment or disposal.
<b>Invert</b>	The lowest point of a channel inside a pipe or manhole.
<b>Inverted Siphon</b>	A pressure pipeline used to carry wastewater flowing in a gravity collection system under a depression, such as a valley or roadway, or under a structure such as a building and up to the original line of flow.
<b>Iodometric Titration</b>	The determination of residual chlorine by adding potassium iodide and by titrating liberated iodine with sodium thiosulfate. Starch solution is used as a colorimetric indicator to determine the end point.
<b>K</b>	
<b>Kite</b>	A device for hydraulically cleaning sewer lines. Resembling an airport wind sock and constructed of canvas-type material, the kite increases the velocity of flow at its outlet to wash debris ahead of it.
<b>L</b>	
<b>Lamping</b>	Use of reflected sunlight or a powerful light beam to inspect a sewer between two adjacent manholes. Light is directed down the pipe from one manhole; if it can be seen from the next manhole, this indicates that the line is open and straight.
<b>Lateral Sewer</b>	A sewer which discharges into a branch or other sewer and has no other common sewer tributary to it -- used to collect wastewater from individual homes.

**Launder** Trough(s) in clarifiers which collect effluent and allow it to flow out of the clarifier.

**Leaching** The process by which soluble materials are washed out of the upper soil layer and down to a lower layer by percolating water.

**Lift Station** A wastewater pumping station which lifts the wastewater to a higher elevation. It is used when the continuance of the gravity sewer would involve excessive depths or when pumping wastewater from areas too low to drain by gravity into available sewers.

**Lodging** The bending and breaking of field crops caused by excessive nitrogen, rain, wind or crop disease.

## **M**

**Main Sewer** Sewer line which receives wastewater from many tributary branches and sewer lines and serves as an outlet for a large territory.

**Mandrel**

- 1) A special tool used to push bearings in or to pull sleeves out.
- 2) A gauge used to measure excessive deflection in a flexible conduit.

**Manhole** A structure in a sewer provided to permit workers or equipment to enter or leave.

**Manometer** A glass tube filled with a liquid and used to measure the difference in pressure across a flow-measuring device such as an orifice or a venturi meter.

**Masking Agents** Chemicals which are dripped into wastewater, sprayed into the air, or evaporated into the air to make undesirable odors less noticeable.

**Mechanical Aeration** A process by which the surface of an aeration tank is mechanically agitated resulting in aeration and mixing of the liquid.

<b>Mechanical Plug</b>	A mechanically expanded pipe plug used in sewer system to create a seal.
<b>Media</b>	The material in a trickling filter over which settled water is sprayed during treatment. Organisms grow on the surface of the media and treat wastewater.
<b>Meniscus</b>	The curved surface on the top of a column of liquid (water, oil, mercury) in a small tube. Water will form a valley when the liquid wets the walls of the tube, while mercury will form a mound when the walls of the tube are not wetted.
<b>Mesophilic Bacteria</b>	Group of bacteria which thrive in a temperature range between 68°F and 113°F.
<b>Methane</b>	A colorless, odorless, inflammable gaseous hydrocarbon formed by the decomposition of organic matter.
<b>Micro-organisms (Bugs)</b>	Very small organisms which can be seen only through a microscope. Some micro-organisms use the wastes in wastewater for food and thus remove or alter much of the undesirable matter.
<b>Milligrams/Liter (mg/l)</b>	A standard expression of concentration pertaining to substances found in water or wastewater -- can be considered equivalent to parts per million in wastewater applications (1 mg/l = 1 ppm).
<b>Mixed Liquor</b>	A mixture of activated sludge (bugs) and wastewater in an aeration tank.
<b>Mixed Liquor Suspended Solids (MLSS)</b>	Suspended solids or nonfilterable solid particles in mixed liquor.
<b>Mixed Liquor Volatile Suspended Solids</b>	That portion of the mixed liquor suspended solids which are volatile (organic). This test more accurately estimates the micro-organism concentration than the MLSS test.
<b>Most Probable Number (MPN)</b>	Number of bacterial organisms per unit volume which, in accordance with statistical theory, is most likely to yield the test result.

# N

## Nitrogen

A gaseous element which is a major plant nutrient.

### Available Nitrogen

The nitrogen present in inorganic forms ( $\text{NH}_3$  - N and Nitrate) which are available for plant growth.

### Ammonia Nitrogen

( $\text{NH}_3$ -N) inorganic nitrogen.

### Kjeldahl Nitrogen

A measure of the total nitrogen present in a sample. Organic nitrogen plus ammonia nitrogen equals Kjeldahl nitrogen.

### Organic Nitrogen

Represents the nitrogen present in a sample which is combined in organic matter and is slowly released by decaying organics.

## Nitrification

The biochemical conversion of unoxidized nitrogen (ammonia and organic N) to oxidized nitrogen (usually nitrate).

## Nutrients

Elements essential to support life such as carbon, hydrogen, oxygen, nitrogen, sulfur, and phosphorus. Nitrogen and phosphorus are of major concern because they tend to recycle and are hard to separate because of solubility in water.

### Macronutrients

Major nutrients which plants need to grow. This includes nitrogen, phosphorus and potassium.

### Micronutrients

Minor nutrients which plants need to grow. This includes zinc, copper, manganese and other minerals.



## O

<b>Ohm</b>	A unit of electrical resistance -- the resistance of a conductor in which one volt produces a current of one ampere.
<b>Organic Loading</b>	The amount of organic materials applied to a treatment process in a specified length of time -- often expressed as pounds of BOD per unit times per unit volume.
<b>Orifice</b>	An opening in a plate, wall or partition. An orifice plate set in a pipe which consists of a slot or hole smaller than the pipe diameter. Difference in pressure in the pipe above and below the orifice plate can be related to flow in the pipe.
<b>Outfall</b>	<ol style="list-style-type: none"><li>1) The point, location, or structure where wastewater or drainage discharges from a sewer, drain or other conduit.</li><li>2) The conduit leading to the ultimate disposal area.</li></ol>
<b>Oxidation</b>	The addition of oxygen to a compound.

## P

<b>Packing Ring</b>	Ring made of asbestos or metal, which may be lubricated with Teflon or graphite, which forms a seal between the pump shaft and its casing.
<b>Parachute</b>	A device which fills with wastewater flow and is used to pull a float line between manholes.
<b>Parallel Operation</b>	A condition where the flow is divided proportionally among similar units.
<b>Parameter</b>	A specific subject or control area having variable values, which is used with other parameters to define a situation or larger subject area.
<b>Parasites</b>	Organisms which are capable of causing disease in a host. These include viruses, bacteria and other organisms.

<b>Parts Per Million (ppm)</b>	A unit of concentration signifying parts of some substance per million parts of the dispersing medium on a weight basis [example: 1 ppm = 1 pound of sugar in 1 million pounds of water (119,904 gallons)].
<b>Pathogens</b>	Bacteria or viruses which can cause disease (e.g., typhoid, cholera, dysentery).
<b>Percent Removal</b>	The percent of material removed from processed water in terms of the material entering -- sometimes referred to as reduction.
<b>Perennial</b>	Crops which do not need to be replanted each year. This includes grasses such as clover, alfalfa and hay.
<b>Phosphates</b>	A material which contains compounds of phosphorus which are available for plant growth. Too many phosphates may cause possible eutrophication of waters.
<b>Photosynthesis</b>	A process in which plants use sunlight and chlorophyll ( a green pigment found in algae and higher plants) to convert carbon dioxide and inorganic substances to oxygen and additional plant material).
<b>pH</b>	A measure of the relative alkalinity/acidity of a material which ranges from 0 to 14 with 7 being neutral. It is the measure of the negative log of hydrogen ions present in a substance.
<b>Pin Floc</b>	Very fine floc particles with poor settling characteristics.
<b>Pneumatic Ejector</b>	A device for pumping wastewater, sludge or other liquid by alternately admitting it through an inward-swinging check valve into the bottom of an airtight pot. It is then discharged through an outward-swinging check valve by admitting compressed air to the pot above the wastewater.
<b>Pollution</b>	Materials in water which produce harmful, objectionable or nuisance effects in the water -- such as sewage, industrial wastes, heat, solids, etc.
<b>Polymer</b>	A high-molecular-weight chemical used to aid in coagulation.

<b>Ponding</b>	<ol style="list-style-type: none"> <li>1) A trickling filter condition where voids in the media become plugged to the extent that the wastewater will not flow through it.</li> <li>2) Hydraulic overloading of soil where liquids collect on the surface of the earth. Ponding is created by any number of conditions which prevent moisture from percolating into the soil.</li> </ol>
<b>Population Equivalent</b>	A means of expressing the concentration of material in wastewater in terms of number of people. Domestic wastewater on the average contains approximately 0.17 pound of BOD and 0.2 pound of TSS per person per day.
<b>Potable Water</b>	Water which does not contain objectionable pollution, contamination, minerals, or infectious agents and is considered satisfactory for human consumption.
<b>Preaeration</b>	A wastewater preliminary treatment process consisting of aeration to remove gases, add oxygen, promote flotation of grease and aid coagulation.
<b>Precipitate</b>	The solids which settle out of a liquid as a result of the precipitation process.
<b>Precipitation</b>	<ol style="list-style-type: none"> <li>1) The total measurable supply of water received directly from clouds as rain, snow, hail, or sleet -- usually expressed as depth in a day, month or year and designated as daily, monthly or annual precipitation.</li> <li>2) The phenomenon which occurs when a substance held in solution in a liquid passes out of solution into solid form.</li> </ol>
<b>Preliminary Treatment</b>	Treatment preceding normal primary and secondary treatment. It is usually considered to include bar screens, grit chambers and comminution -- may include flocculation or disinfection - generally for the protection of subsequent treatment units and equipment.
<b>Primary Treatment</b>	The first <u>major</u> unit in a treatment plant which uses physical sedimentation to remove the greatest percentage of suspended solids.

<b>Probe</b>	<ol style="list-style-type: none"> <li>1) A T-shaped tool or rod which is pushed or driven down through the soil to locate underground pipes and utility conduits.</li> <li>2) Testing instrument immersed or partially immersed in a sample for measurement of DO or pH.</li> </ol>
<b>Protozoa</b>	A group of microscopic one-celled animals, which feed upon bacteria, other small animal cells and bits of plant life.
<b>Putrefaction</b>	Biological decomposition of organic matter, with the production of ill-smelling products associated with anaerobic conditions.
<b>Putrescible</b>	Describing material which will decompose under anaerobic conditions and produce nuisance odors.
<b>R</b>	
<b>Raw Sludge</b>	Settled sludge promptly removed from primary clarifiers before decomposition has advanced much -- frequently referred to as undigested sludge.
<b>Raw Wastewater</b>	Wastewater as it is received from the collection system before it has received any treatment.
<b>Reagent</b>	A substance which takes part in a chemical reaction and is used to measure, detect or examine other substances.
<b>Receiving Water</b>	A stream, river, lake or ocean into which treated or untreated wastewater is discharged.
<b>Recirculation</b>	The return of part of the effluent from a treatment unit to the influent of the unit or a preceding unit.
<b>Representative Sample</b>	A portion of material or water identical in content to that in the larger body of material or water being sampled.
<b>Respiration</b>	The physical and chemical processes by which an organism supplies its cells and tissues with oxygen needed for metabolism and relieves them of carbon dioxide.

<b>Respiration Rate</b>	The rate of oxygen uptake by micro-organisms. In activated sludge, a measure of the oxygen uptake rate per gram of MLSS.
<b>Rodding Machine</b>	Machine designed to feed a rod into a pipe while rotating it.
<b>Rotifer</b>	A microscopic animal which is composed of several cells and possesses cilia (hair-like structures), which are used for locomotion and for food intake.
<b>Rotating Biological Contactor (RBC)</b>	A rotating bed of synthetic media which is partially submerged and rotated in a tank through which wastewater flows. A zooglear film on the media breaks down the organic matter in the wastewater.
<b>Rotometer</b>	A device used to monitor or meter the flow or application of chemicals.
<b>Row Crop</b>	A crop such as corn, beans, or beets, usually grown or cultivated in rows.
<b>Runoff</b>	That part of rain or other precipitation which runs off the surface of a drainage area and does not enter the soil.
<b>S</b>	
<b>Saddle Connection</b>	A building service connection made to a sewer main with a device called a saddle. This device makes a tight seal against the main pipe by use of a clamp, adhesive or gasket and prevents the service pipe from protruding into the main.
<b>Sand Trap</b>	A device which can be placed in the outlet of a manhole to cause settling in the manhole invert, thus trapping sand, rocks and similar inorganic debris.
<b>Sanitary Sewer</b>	Sewer designed to receive and convey household, commercial or industrial wastewater.
<b>Saprophytic Organisms</b>	Organisms living on dead matter. They help natural decomposition of organic solids in wastewater.

<b>Saturated Soil</b>	Soil which has its void spaces filled with water to the point at which runoff occurs.
<b>Scooter</b>	A sewer-cleaning tool whose cleansing action depends on high water velocity around the outside edge of a circular shield. The metal shield is rimmed with a rubber coating and is attached to a framework on wheels (like a child's scooter). The angle of the shield is controlled by a chain-spring system which regulates the head of water behind the scooter and, thus, the cleansing velocity of the water flowing around it.
<b>Screen</b>	A device with openings generally uniformly sized to retain or remove suspended or floating objects in wastewater larger than the openings.
<b>Screenings</b>	Materials, consisting largely of rags and paper, which are removed from wastewater by means of bar screens, basket screens or other types of straining devices.
<b>Scum</b>	<ol style="list-style-type: none"> <li>1) The layer or film of foreign matter, particularly grease, which rises to the surface of water or wastewater.</li> <li>2) A residue deposited on the ledge of a sewer, channel or wet well at the water surface.</li> <li>3) A mass which floats on the surface.</li> </ol>
<b>Secondary Treatment</b>	The process by which dissolved and suspended organic materials are converted to settleable forms which are removed from the wastewater. This is usually accomplished by using biological treatment processes such as activated sludge, trickling filters, stabilization ponds, rotating biological contactors, etc.
<b>Sedimentation</b>	The process of settling suspended solids by gravity.
<b>Septic</b>	A condition produced by the lack of aerobic conditions. If severe, the wastewater turns black, giving off foul odors and creating a heavy oxygen demand.
<b>Septic Tank</b>	A tank which allows solids in the wastewater to settle and decompose by anaerobic bacterial action and allows the liquids in wastewater to exit from the tank for further treatment.

<b>Series Operation</b>	A method of operation where the flow from one unit goes to a similar second unit, as in two-stage trickling filters.
<b>Service Connection</b>	Any single pipe, gate, valve or similar means of transfer to a main collection system from any individual building.
<b>Settleability Test</b>	Settling test conducted in a 1,000 ml cylinder for 30 minutes.
<b>Settleometer Test</b>	Settling test conducted in a 2,000 ml beaker for 60 minutes.
<b>Sewage</b>	The used water and water-carried solids from homes and industries which flow in sewers to a treatment plant. Preferred term is "WASTEWATER."
<b>Sewer</b>	A pipe or conduit which carries wastewater or storm water.
<b>Sewer Ball</b>	A spirally-grooved, inflatable, semi-hard rubber ball designed for hydraulic cleaning of sewer pipes.
<b>Sewer Gas</b>	<ol style="list-style-type: none"> <li>1) Gas in collection lines (sewers) which is caused by the decomposition of organic matter in the wastewater.</li> <li>2) Any gas present in the wastewater collection system even though it is from such sources as gas mains, gasoline, cleaning fluid, etc.</li> </ol>
<b>Sewer Jack</b>	A device placed in manholes which supports a yoke or pulley which keeps wires or cables from rubbing against the inlet or outlet of a sewer.
<b>Sheeting</b>	Solid material such as wooden sheets or metal plates used to hold back soil and prevent cave-ins during excavation.
<b>Shock Load</b>	A situation where the influent wastewater flow contains waste of a toxic nature or with very high organic or hydraulic content, or when the pH either drops or rises drastically -- usually detrimental to the treatment process.
<b>Shoring</b>	Material such as boards, planks or plates and hydraulic jacks, used to hold back soil around trenches and to protect workers in a trench from cave-ins.
<b>Short-Circuiting</b>	The hydraulic condition in a tank, chamber or basin where time of passage is less than that of the intended flow-through period.

<b>Sinkhole</b>	A closed depression in an area of Karst topography which is formed by washing away of the underlying limestone and acts as a recharge area for ground water.
<b>Slope</b>	Grade or inclination of a sewer or trench excavation. The ratio of the vertical to the horizontal distance, or “rise over run.”
<b>Sloughings</b>	Trickling-filter zoogical film which has been “washed off” the filter media.
<b>Sludge</b>	The settleable solids separated from liquids during processing, or accumulated deposits on the bottom and edges of wastewater collection lines and appurtenances.
<b>Sludge Blanket</b>	Layer of sludge suspended within an enclosed body of wastewater, such as a clarifier.
<b>Smoke Test</b>	A method of blowing smoke into a sanitary sewer system to locate sources of inflow.
<b>Snake</b>	A stiff yet flexible cable which is inserted into sewers to clear stoppages.
<b>Soil</b>	A porous mixture with varying amounts of mineral particles, biological organisms and water.
<b>Soil Horizon</b>	A layer of soil approximately parallel to the land surface and different from layers either above or below that layer.
<b>Soil Profile</b>	A vertical section of the soil from the surface through all of the horizons.
<b>Soil Structure</b>	The combination and physical arrangement of soil particles.
<b>Soil Texture</b>	The relative proportion of the various size groups of soil grains in a soil. Sand particles are between 2 and 0.05 mm in diameter. Silt particles are between .05 and .002 mm in diameter. Clay particles are less than .002 mm in diameter.
<b>Soil Type</b>	A body of soil having the same profile and texture. It is the lowest unit in the soil classification system.



## **Solids**

A substance which has its own distinctive shape.

### Dissolved Solids

- 1) Very small, invisible, nonsettling particles which are in solution and are not capable of being removed by filtration.
- 2) The difference between total and suspended solids.

### Inorganic Solids

Chemical substances of mineral origin and not readily biodegradable, e.g., sand, grit and glass.

### Organic Solids

Chemical substances of animal and vegetable origin basically with a carbon structure.

### Settleable Solids

Those solids which will settle out when a sample of wastewater is allowed to stand quietly for a one-hour period; this is measured in an Imhoff cone.

### Suspended Solids

The concentration of insoluble materials suspended or dispersed in water or wastewater, generally expressed in mg/l on a dry-weight basis and determined by filtration methods.

### Total Solids

Solids contained in dissolved and suspended forms in water -- determined by weighing after drying at 103°C.

### Volatile Solids

Quantity of solids in water which represents a loss in weight upon ignition at 550°C.

<b>Specific Gravity</b>	The density of a substance relative to the density of an equal volume of pure water at 25°C. Specific gravity of 1.0 is assigned to pure water; substances having a specific gravity of 2.0 are twice as dense as water.
<b>Spoil</b>	Excavated material such as soil from the trench of a sewer.
<b>Spray Irrigation</b>	A method of disposing of wastewater by spreading it on land -- usually from pipes equipped with spray nozzles.
<b>Stabilization Pond</b>	A secondary treatment system in which natural purification processes occur under controlled conditions. Interaction between algae and bacteria plays a vital role in this process.
<b>Standard Methods</b>	Methods of testing prescribed by joint action of the APHA, AWWA and WPCF.
<b>Static Head</b>	When water is not moving, the vertical distance (in feet) from a point to the water surface.
<b>Sterilization</b>	The destruction of all living organisms ordinarily through the agency of heat, chemicals or light.
<b>Stilling Well</b>	A pipe, chamber, or compartment with a relatively small inlet(s) connected to a main body of water, such as water in a wet well. The purpose of a stilling well is to dampen waves or surges while allowing the water level within the well to rise and fall with the major fluctuations of the main body of water. It is used with water-measuring flow and depth devices to improve the accuracy of measurement.
<b>Storm Sewer</b>	Sewer which carries storm water and surface water, street wash and other wash waters or drainage. This excludes domestic wastewater and industrial wastes.
<b>Stringers</b>	Horizontal shoring members, usually square, rough-cut timber, which are used to hold solid sheeting, braces or vertical shoring members in place.
<b>Suction Head</b>	The pressure (in feet or psi) on the suction side of a pump. Pressure is usually measured from the center line of the pump impeller <u>up to</u> the water surface elevation of the wet well.

<b>Suction Lift</b>	The <u>negative</u> pressure (in feet or inches of mercury vacuum) on the suction side of a pump, the <u>negative</u> pressure usually resulting from the pump being located above the water level.
<b>Supernatant</b>	The liquid removed from settled sludge. Supernatant commonly refers to the liquid between the sludge on the bottom and the scum on the surface of any liquid. This liquid is usually returned to an influent wet well or a primary clarifier.
<b>Supersaturation</b>	The situation in which water holds more oxygen at a specified temperature than normally required for saturation at that temperature.
<b>Surcharge</b>	A condition in which the surface of wastewater in a manhole is above the top of a sewer pipe. The sewer is under pressure or at a head rather than at atmospheric pressure.
<b>Symbiotic Cycle</b>	The symbiotic relationship between bacteria and algae in a stabilization pond system.
<b>T</b>	
<b>Tag Line</b>	Line, rope or cable which follows equipment through a sewer so the equipment can be pulled back out if it encounters an obstruction or becomes stuck. Equipment is pulled forward with a pull line.
<b>Tertiary Treatment</b>	Treatment in addition to normal or conventional secondary methods.
<b>Titrate</b>	To add a chemical solution of known strength on a drop-by-drop basis until a color change, precipitate or pH change in the sample is observed (end point). Titration is the process of adding the chemical solution up to completion of the reaction as signaled by the end point.
<b>Total Dynamic Head (TDH)</b>	(Sometimes referred to as Total Head). The total amount of energy (expressed as feet of water) required to achieve a specified flow rate through a particular piping network at a particular static head. TDH is the sum of the static head, the friction head loss and the velocity head.

<b>Totalizer</b>	A recorder which continuously sums flow.
<b>Toxic Load</b>	A poison or acting like a poison - something detrimental to a biological treatment process, e.g., fuel oil, chromium salts, etc.
<b>Toxicity</b>	A condition which may inhibit or destroy the growth or function of any organism.
<b>Trench Jack</b>	A mechanical screw device used to hold shoring in place.
<b>Trickling Filter</b>	A biological treatment process in which the wastewater trickles through a bed of media and is treated by the action of micro-organisms living on the filter media.
<b>Trunk Sewer</b>	Sewer which receives many tributary branches and serves a large territory.
<b>Turbidity</b>	<ol style="list-style-type: none"> <li>1) A condition in water or wastewater caused by the presence of suspended matter, resulting in the scattering and absorption of light rays and causing a cloudy appearance.</li> <li>2) An analytical quantity usually reported in turbidity units determined by measurements of light diffraction.</li> </ol>
<b>U</b>	
<b>Underdrains</b>	<ol style="list-style-type: none"> <li>1) A system of drain tiles which are placed deep enough to allow the covering soil to be cultivated. The underdrains keep the soil profile free of excessive moisture.</li> <li>2) A system of slotted or perforated pipes placed in the soil to collect water for drainage to another area.</li> </ol>
<b>Unloading</b>	A term pertaining to the seasonal sloughing of solids from the trickling filter media.

## **V**

<b>Valves</b>	A mechanical device for regulating the flow of liquid.
<b>Virus</b>	A submicroscopic agent capable of causing disease which grows only inside living cells.
<b>Void</b>	A pore or open space in rock or granular material not occupied by solid matter. It may be occupied by air, water or other gaseous or liquid materials.
<b>Volatile</b>	Capable of being converted from a liquid or solid into a gas or vapor.
<b>Voltage</b>	The electrical pressure available to cause a flow of current (amperage) when an electrical circuit is closed.
<b>Volute</b>	The spiral-shaped casing surrounding a pump impeller.

## **W**

<b>Walers</b>	Horizontal shoring members, usually square rough-cut timbers, which are used to hold solid sheeting, braces, or vertical shoring members in place.
<b>Wastewater</b>	The used water and water-carried solids from a community.
<b>Waterborne Disease</b>	Disease caused by organisms or toxic substances carried by water. Most common waterborne diseases are typhoid fever, Asiatic cholera, polio, dysentery and other intestinal disturbances.
<b>Watershed</b>	A region or land area which supplies water to a wetland, lake or river during precipitation, snowmelt and/or runoff. A catchment area or drainage basin.
<b>Water Table</b>	The upper surface of ground water or that level where the soil is saturated with water. High ground waters can be estimated by observing soil color or mottling when investigating the soil profile.

**Weir**

- 1) A vertical obstruction such as a wall placed in an open channel and calibrated so that a flow over the weir can easily be converted to a flow rate.
- 2) A device used for surface overflow from a tank, basin or chamber -- generally designed to smooth out discharge flows so as to minimize turbulence and currents.

**Wet Well**

A compartment or room in which wastewater is collected, and to which the suction pipe of a pump is connected. Also, a submersible pump may be located in a wet well.

**Z****Zooglea**

Jelly-like mass of micro-organisms composing the trickling filter slime.

